

Reference Manual

RCT 5023-G

**Rack Controller with LAN connectivity,
GPI Control, APPolo GUI
and OH_RCT5023_SERVER Option**

Revision 1.2 – October 2020

This Manual Supports Device Revisions:	
RCT 5023-G Firmware Revision	542
Control System GUI Release	6.3.0
Embedded Server Release	6.3.0

Information in this document is subject to change without notice. No part of this document may be reproduced or transmitted in any form or by any means, electronic or mechanical for any purpose, without express written permission of LYNX Technik AG.

LYNX Technik AG may have patents, patent applications, trademarks, copyrights or other intellectual property rights covering the subject matter in this document. Except as expressly written by LYNX Technik AG, the furnishing of this document does not give you any license to patents, trademarks, copyrights or other intellectual property of LYNX Technik AG or any of its affiliates.

LYNX Technik AG
Brunnenweg 3
D 64331 Weiterstadt
Germany
www.lynx-technik.com

Content

WARRANTY	4
REGULATORY INFORMATION	5
Europe	5
USA5	
GETTING STARTED	6
Packaging	6
ESD Warning	6
Preventing ESD Damage	6
PRODUCT DESCRIPTION	7
INSTALLATION	8
CONTROLLER REMOVAL	9
FUNCTIONAL DIAGRAM	10
MODULE LAYOUT	11
CONNECTIONS	12
Service Connection	12
Rack Frame Connections	12
Alarm Connection	12
Alarm Function	12
GPI Control.....	13
LAN Connection	15
SETTINGS AND CONTROL	15
Reset Button	15
ALARM/LED STATUS INDICATORS	16
General Status LED.....	16
Controller Status LED` s.....	16
Status LED 1	16
Status LED 2	16
Status LED 3	16
Status LED 4	16
Status LED 5	16
Power Indication	16
NETWORK CONFIGURATIONS	17
How to attach a RCT 5023-G Editor)	(Network Configurations 17
Controller Network Configuration Configuration)	(Network Component 19
Default IP Address.....	19
Setting IP Addresses	19
Activation of DHCP Mode	20
APPolo GUI Software	21

System Requirements	21
Software Installation	21
Starting the Controller Application	25
Software Updates	25
Software Version Number	25
Reporting Problems	26
Collect Service Information	26
Software Operation	28
Control System Layout	28
Device List	29
User Defined Device List	30
Module Properties	31
New Control Window	31
Module Rename	31
Module Title Area	32
Locate Function	32
Control Tabs	33
Power Supply Tab	33
Settings Tab	34
Hotsync	34
Switching on Hotsync	34
Hotsync Function	35
Hotsync Indications	36
Network	37
Log in GUI Function	38
SNMP Support	38
Event Logging Area	38
Update Manager	39
Server Option (OH_RCT5023_Server)	43
Installation	43
Control Tabs	45
Connection Tab	46
System Events Tab	46
Options Tab	47
Logfiles Tab	48
Web Interface Tab	48
Web Interface for Option OH_RCT5023_Server	49
Remote Interfaces (for Option OH_RCT5023_Server)	51
SNMP Feature	51
LYNX Remote Control Interface	52
GPI Control	53
SPECIFICATIONS	56
SERVICE	57
Parts List	57
Technical Support	57
CONTACT INFORMATION	57

Warranty

LYNX Technik AG warrants that the product will be free from defects in materials and workmanship for a period of three (3) years from the date of shipment. If this product proves defective during the warranty period, LYNX Technik AG at its option will either repair the defective product without charge for parts and labor, or will provide a replacement in exchange for the defective product.

In order to obtain service under this warranty, customer must notify LYNX Technik of the defect before expiration of the warranty period and make suitable arrangements for the performance of service. Customer shall be responsible for packaging and shipping the defective product to the service center designated by LYNX Technik, with shipping charges prepaid. LYNX Technik shall pay for the return of the product to the customer if the shipment is within the country which the LYNX Technik service center is located. Customer shall be responsible for payment of all shipping charges, duties, taxes and any other charges for products returned to any other locations.

This warranty shall not apply to any defect, failure, or damage caused by improper use or improper or inadequate maintenance and care. LYNX Technik shall not be obligated to furnish service under this warranty a) to repair damage resulting from attempts by personnel other than LYNX Technik representatives to install, repair or service the product; b) to repair damage resulting from improper use or connection to incompatible equipment; c) to repair any damage or malfunction caused by the use of non LYNX Technik supplies; or d) to service a product which has been modified or integrated with other products when the effect of such modification or integration increases the time or difficulty servicing the product.

THIS WARRANTY IS GIVEN BY LYNX TECHNIK WITH RESPECT TO THIS PRODUCT IN LIEU OF ANY OTHER WARRANTIES, EXPRESS OR IMPLIED. LYNX TECHNIK AND ITS VENDORS DISCLAIM ANY IMPLIED WARRANTIES OF MERCHANTABILITY OR FITNESS FOR A PARTICULAR PURPOSE. LYNX TECHNIK'S RESPONSIBILITY TO REPAIR AND REPLACE DEFECTIVE PRODUCTS IS THE SOLE AND EXCLUSIVE REMEDY PROVIDED TO THE CUSTOMER FOR BREACH OF THIS WARRANTY. LYNX TECHNIK AND ITS VENDORS WILL NOT BE LIABLE FOR ANY INDIRECT, SPECIAL, INCIDENTAL, OR CONSEQUENTIAL DAMAGES IRRESPECTIVE OF WHETHER LYNX TECHNIK OR THE VENDOR HAS ADVANCE NOTICE OF THE POSSIBILITY OF SUCH DAMAGES.

Regulatory information

Europe

Declaration of Conformity

<p>We</p>	<p>LYNX Technik AG Brunnenweg 3 D-64331 Weiterstadt Germany</p>
<p><i>Declare under our sole responsibility that the product</i></p>	
<p>TYPE: RCT 5023-G</p>	
<p><i>To which this declaration relates is in conformity with the following standards (environments E1-E3):</i></p>	
<p>EN 55103-1 /1996 EN 55103-2 /1996 EN 60950-1 /2006</p>	
<p><i>Following the provisions of 89/336/EEC and 73/23/EEC directives.</i></p>	
<p style="text-align: right;">Winfried Deckelmann</p>	
<p>Weiterstadt, January 2013</p>	
<p><i>Place and date of issue</i></p>	<p><i>Legal Signature</i></p>

USA

FCC 47 Part 15

This device complies with part 15 of the FCC Rules. Operation is subject to the following two conditions: (1) This device may not cause harmful interference, and (2) this device must accept any interference received, including interference that may cause undesired operation.

Note: This equipment has been tested and found to comply with the limits for a Class A digital device, pursuant to the part 15 of the FCC Rules. These limits are designed to provide reasonable protection against harmful interference when the equipment is operated in a commercial environment. This equipment generates, uses, and can radiate radio frequency energy and, if not installed and used in accordance with the instruction manual, may cause harmful interference to radio communications. Operation of this equipment in a residential area is likely to cause harmful interference in which case the user will be required to correct the interference at his own expense

Getting Started

The controller card is installed into the rack frames and system tested in the factory. If this is an upgrade part or service exchange item then the module is supplied in a padded cardboard carton which includes the controller card.

Packaging

The shipping carton and packaging materials provide protection for the module during transit. Please retain the shipping cartons in case subsequent shipping of the product becomes necessary. Do not remove the module from its protective static bag unless observing adequate ESD precautions. Please see below.

ESD Warning



This product is static sensitive. Please use caution and use preventative measures to prevent static discharge or damage could result to module.

Preventing ESD Damage

Electrostatic discharge (ESD) damage occurs when electronic assemblies or the components are improperly handled and can result in complete or intermittent failure.

Do not handle the module unless using an ESD-preventative wrist strap and ensure that it makes good skin contact. Connect the strap to any solid grounding source such as any exposed metal on the rack chassis or any other unpainted metal surface.

Caution

Periodically check the resistance value of the antistatic strap. The measurement should be between 1 and 10 Megohms.

Product Description

The RCT 5023-G is a controller option for the R FR 5012/5014 Rack Frame assemblies and provides remote control, status monitoring and event (error) reporting for all LYNX modules installed in the rack.

The option consists of the controller hardware and the required LYNX control software that is designed to operate on a standard Windows compatible PC.

The RCT 5023-G is one component in a scalable and modular control system topology that can expand from a single rack to hundreds of racks located in different locations. This controller supports Ethernet LAN connectivity.

The RCT 5023-G also supports “Smart Update”, i.e. programming of modules through the control software. Newer designs of processing modules support this function. Please contact LYNX for a current list of supported modules.

Through connections on the rack frame termination panel GPI control for up to 9 GPIs (**G**eneral **P**urpose **I**nterface) is provided. This feature allows control of any parameter with simple GPI contacts. Configuration of this function is possible through the APPolo GUI if a LYNX server (e.g. RCT 5031 or OH_RXCT5023-SERVER) is installed in the attached system.

To provide extended control functionality, e.g. Backup-Restore or User Access Control, 3rd party access for remote GPI control etc. a HW option (**OH_RCT5023_SERVER**) is provided.

Installation

If this module was supplied as part of a system it is already installed in the rack enclosure. If the module was supplied as a field upgrade please follow the installation procedure below.



NOTE Observe static precautions when handling card. Please see ESD warnings on Page 5.

We recommend you power the rack down before installing any additional modules into an existing card frame although the RCT 5023-G supports hot swapping.

1. Slide the card module into the card frame. The card should fit easily and should not require excessive force to insert - if you feel any resistance, there could be something wrong with the rear connection panel location. **Do not** try and force the connection this may damage the connectors.
2. The R FR 5012/5014 Card frame has a slot configured for the RCT 5023-G Controller and the card is simply plugged in where shown.

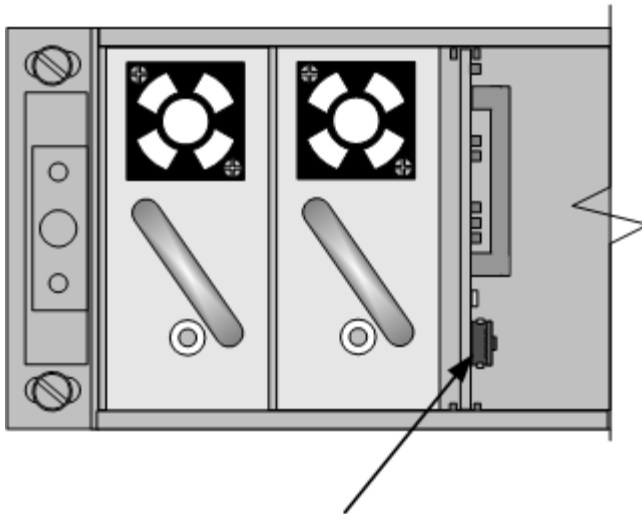

RCT 5023-G Controller Card

3. Power up the rack and check the module LED's. Check the module is automatically logged into the control system device tree. (It may take a few seconds for the control system to "discover" the new module)

NOTE. The use of the optional control system is **mandatory** for the control and setup of this module. If you do not have the control system, then please contact your LYNX representative for details on how to upgrade your rack with the LYNX control system.

Controller Removal

The RCT 5023-G Controller supports hot swapping. There is no need to remove power from the rack to exchange the controller (We recommend you observe standard precautions as described above to prevent static discharge onto the PCB while handling the unit as this may result in damage)

Removal and insertion of the controller will have no effect on the normal operation of the installed Modules. These will operate as previously configured before controller removal, and will resume this mode of operation when a new (and different) controller is installed in its place. All configuration settings are stored in the individual module flash ram storage.

While the rack will operate normally, naturally control of the rack will not be possible when the controller is removed.

When inserting the new RCT 5023-G it will automatically initialize and start running. After a few seconds the control software will detect the presence of the new controller and all modules attached will be accessible from the control system.

Functional Diagram

Below is the basic functional diagram for the RCT 5023-G Controller Module.

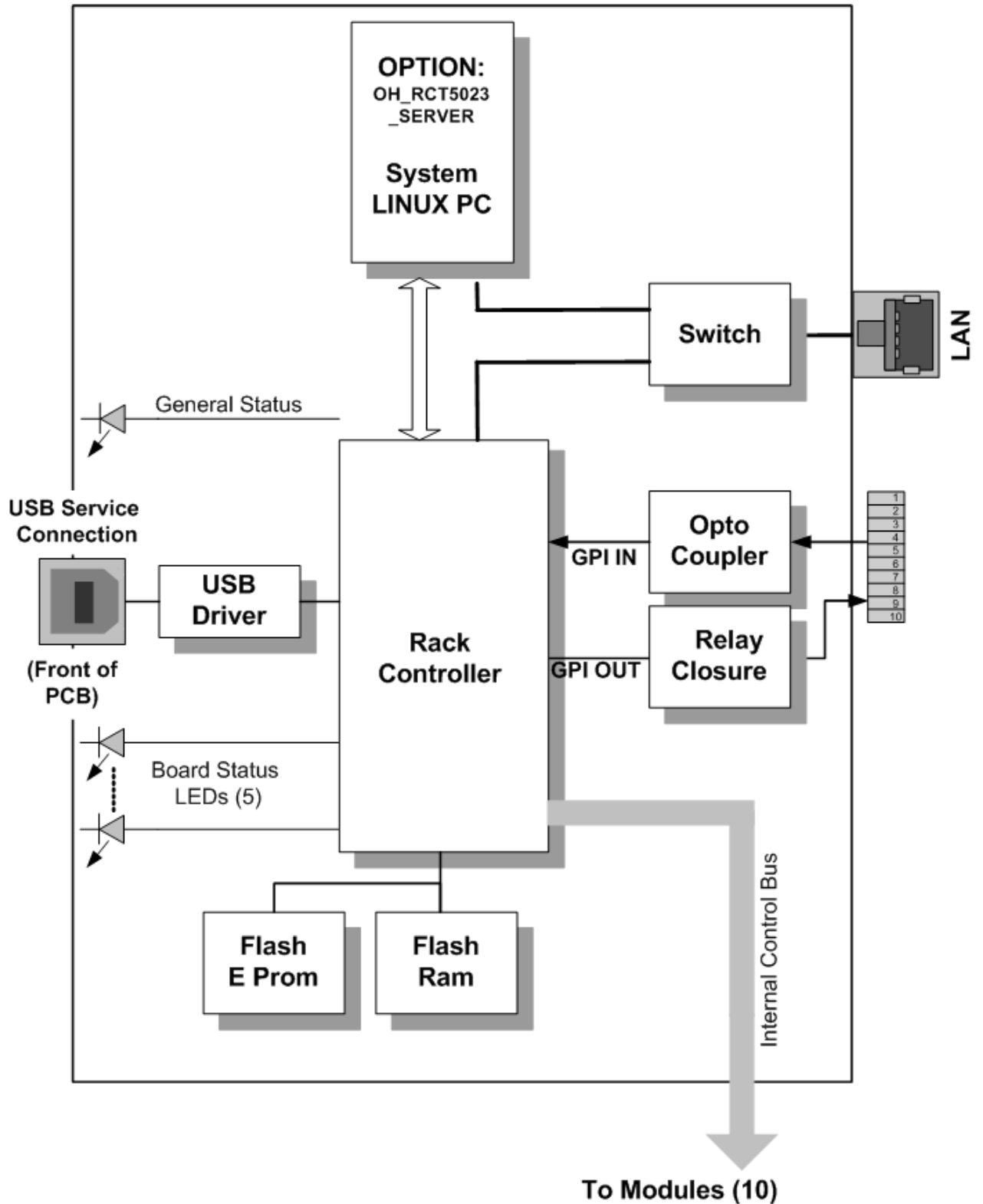

Module Layout

Below the physical layout of the RCT 5023-G CardModule and the locations of the various controls / connections and indicators is shown:

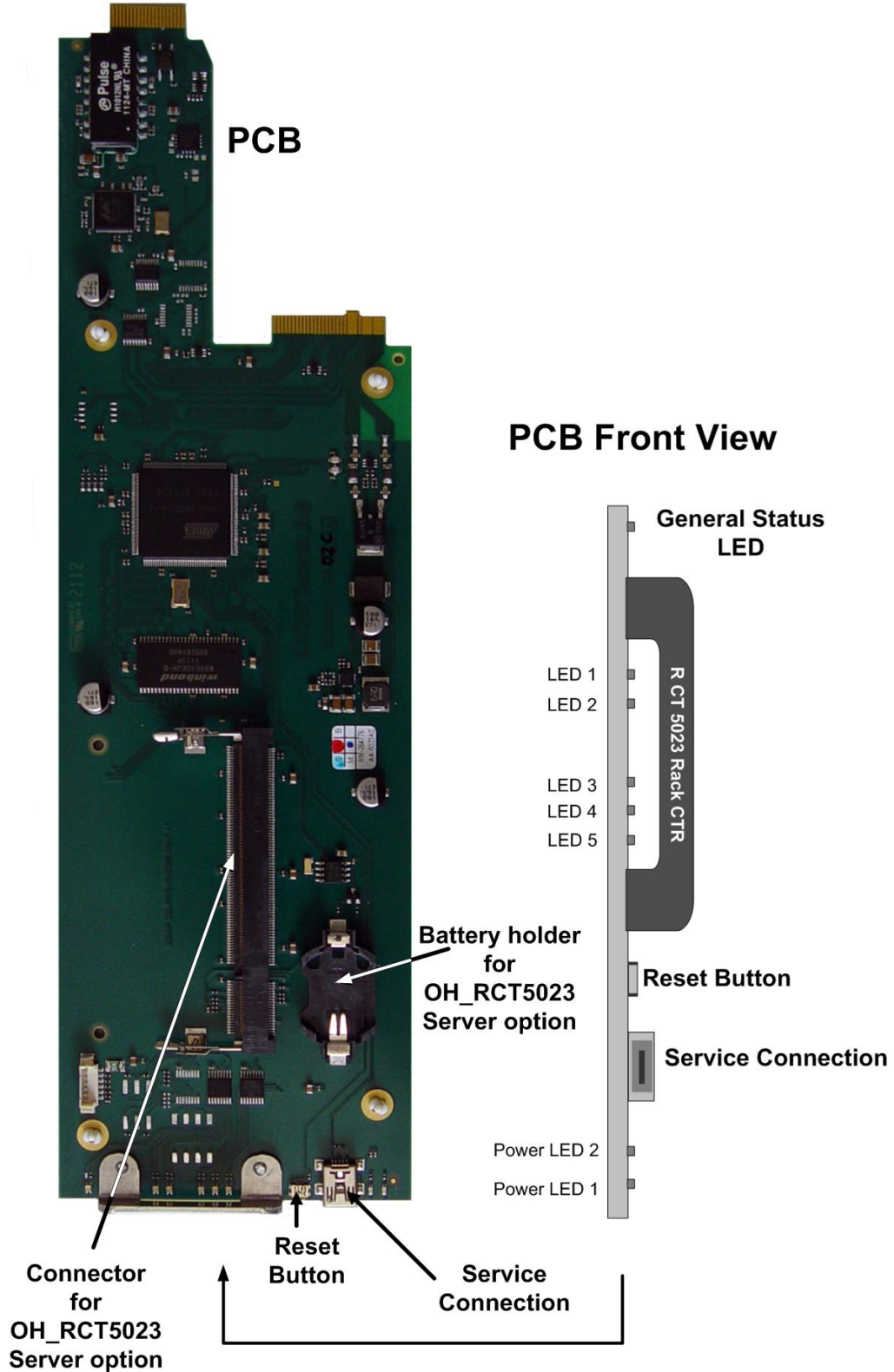

Connections

Service Connection

The RCT 5023-G Controller has a MINI-USB connector on the front of the PCB (see picture above). This is designed for local connection of a PC running the LYNX control system software for testing / engineering purposes.

This connection can be used while the main control software is running on the LAN connection.

NOTE: When you install the APPolo GUI software the necessary Windows drivers for this USB connection will be automatically installed.

Rack Frame Connections

Several connections for use with the RCT 5023-G controller are provided through the terminal panel of the R FR 5012/ 5014 rack frame.

Alarm Connection

An external alarm connection is available from the rack frame (R FR 5012 / 5014).

7B	7A	8B	8A
Alarm Minor B	Alarm Minor A	Alarm Major B	Alarm Major A

Function and connection information is described below.

Alarm Function

The user can assign triggers for the preferred Major / Minor and No Alarm conditions using the controller and supplied software.

The alarm connector provides GPI out contacts for 2 alarm levels and GPI inputs for future use. This allows for the connection of an external monitoring system. Alarm conditions are triggered by the control system and will vary depending on the configuration of the system and user preferences.

For critical failures in the rack a contact can be closed between **Alarm Minor** and **Alarm Common**. Some examples of “critical” type failures:

- Over temperature
- Redundant Power Supply Failure

For major failures in the rack a contact can be closed between **Alarm Major** and **Alarm Common**. One example of a “major” failure in the rack could be:

- Loss of Power

Note: See below in the paragraph “Software Operations” how to set Alarms with the RCT 5023-G

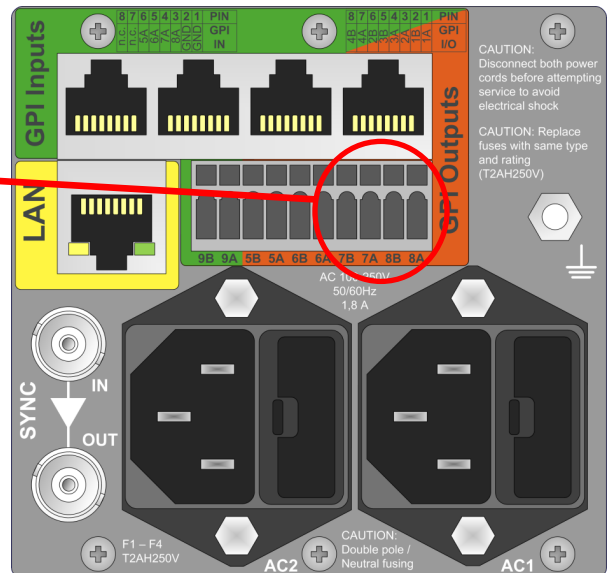

GPI Control

Through connections on the rack frame terminal panel GPI control for up to 9 GPIs (General Purpose Interface) is provided. This feature allows control of any parameter in an attached system with simple GPI contacts (contact closure against GND).

Note. Configuration of this function is possible through the APPolo GUI if a LYNX server (OH_RCT5023-SERVER) is installed in the attached system.

For details of the configuration of the GPI contacts, please see the GUI section of this manual.

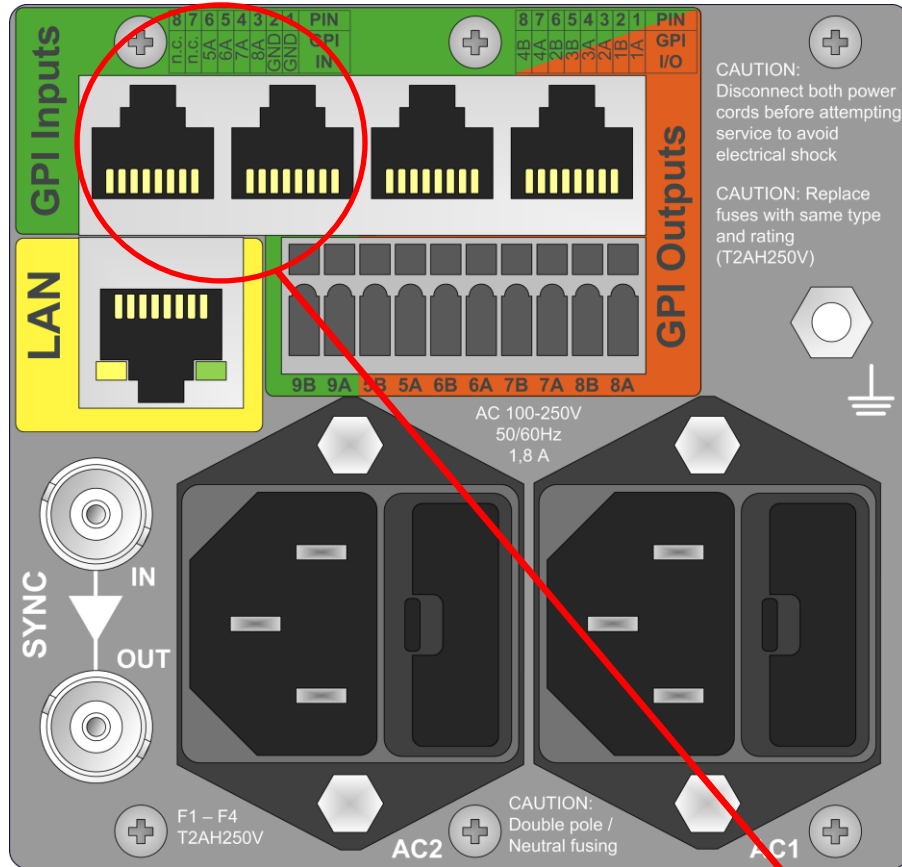

The two RJ45 connectors are looped through, so connections can be done through the one or the other connector. Pinning of the RJ45 connectors is according to TIA/EIA 568-B.

Pin Number	Connection
1	GND
2	GND
3	GPI IN 8
4	GPI IN 7
5	GPI IN 6
6	GPI IN 5
7	n.c.
8	n.c.

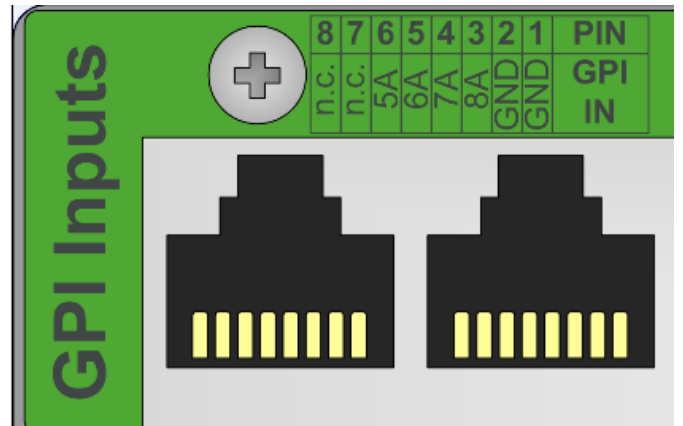

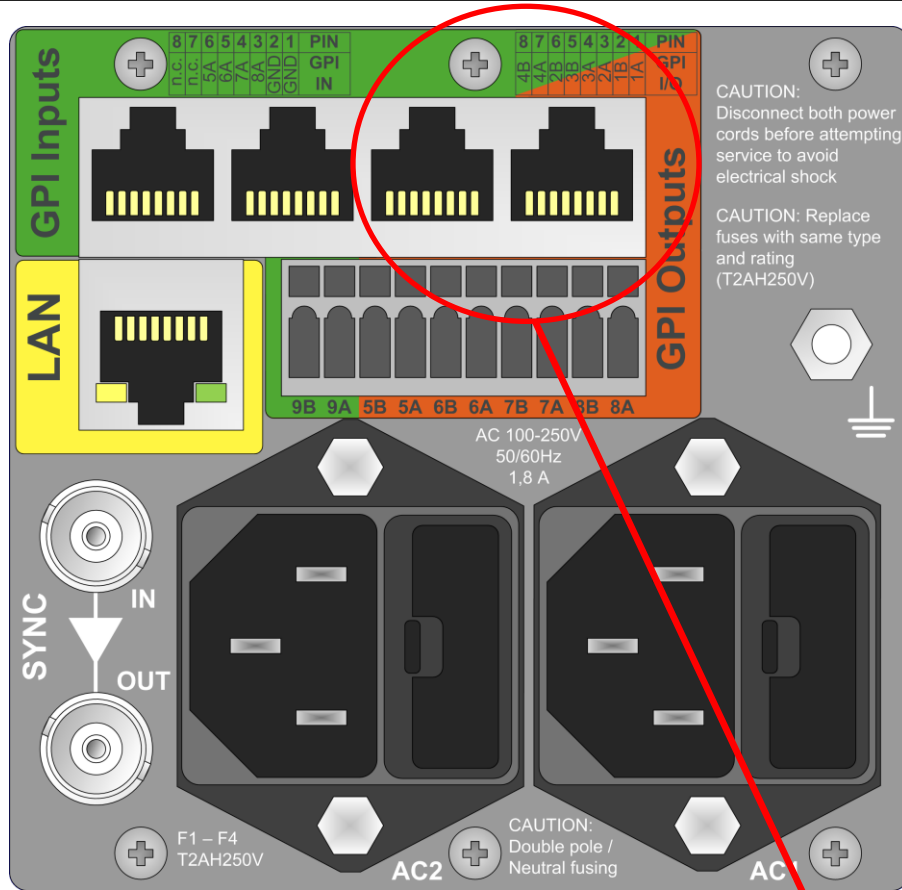

The two RJ45 connectors are looped through, so connections can be done through the one or the other connector. Pinning of the RJ45 connectors is according to TIA/EIA 568-B.

Pin Number	Connection
1	GPI IN 1
2	GND
3	GPI IN 2
4	GPI IN 3
5	GND
6	GND
7	GPI IN 4
8	GND

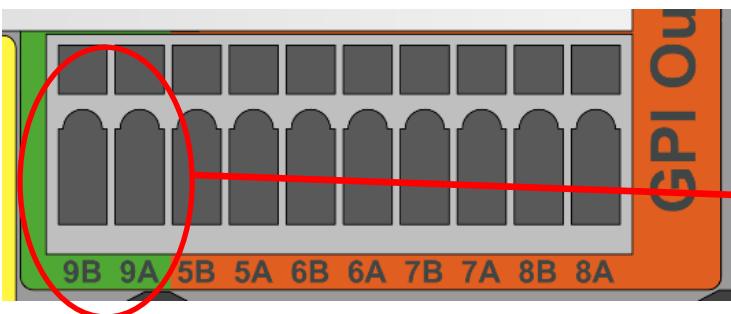
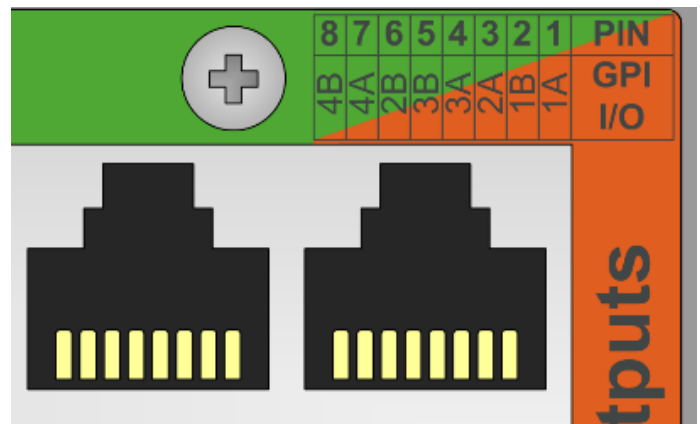

Pin Number	Connection
9B	GND
9A	GPI IN 9

LAN Connection

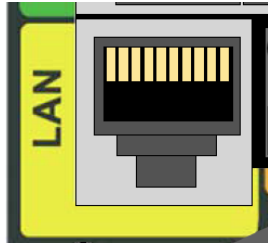

This is a standard RJ45 connection and is used to provide TCP/IP network control connectivity into a control system.

Settings and Control

The RCT 5023-G is configured through the network management utility in the APPolo Control SW (see below in the GUI section of this manual).

Reset Button

There is a RESET button provided on the front edge of the PCB.
 Pressing this button for more than approx.. 5 seconds will reset the RCT 5023-G to the factory configuration including the IP address and ADMIN Password.
 The controller will acknowledge the reset with a 3 x yellow flashing of the LEDs.

PCB Front View

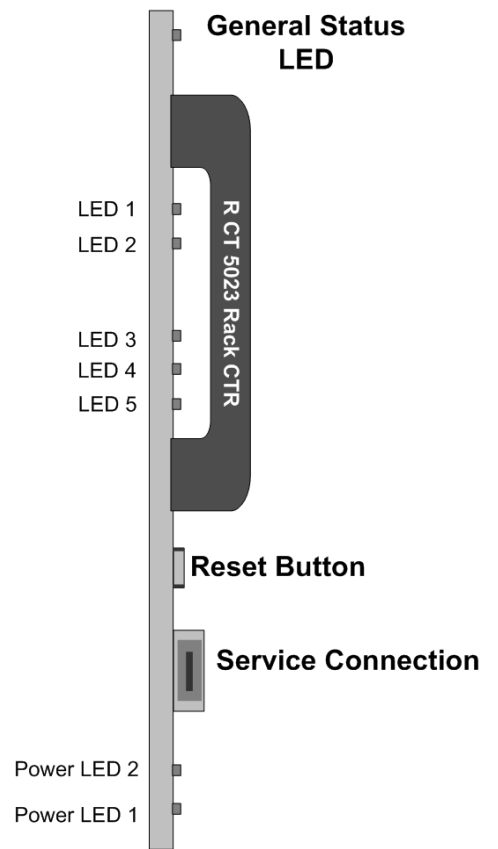

Alarm/LED Status Indicators

The RCT 5023-G module has LED indicators that serve as alarm and status indication for the module. Function is described below.

General Status LED

There is single general status LED on the top of the module.

LED Color	Indication
Green	Indicates normal operation
Yellow Flashing	Module saves current configuration

Controller Status LED`s

A stack of 5 LEDS (LED1...LED5) are used to indicate controller status. Function is described below.

Status LED 1

LED Color	Indication
Green	Hotsync active and no data to be written to any card
Yellow	Controller writes data to cards (Restore)
OFF	Hotsync deactivated

Status LED 2

LED Color	Indication
Green	Hotsync active and no data saved
Yellow	Controller saves data from cards (Backup)
OFF	Hotsync deactivated

Status LED 3

LED Color	Indication
Green	Ethernet/LAN connection active
Yellow	DHCP failure (no DHCP address assigned)
Red	Network Error
OFF	Ethernet/LAN connection not active

Status LED 4

LED Color	Indication
Green	USB Service connection in use
OFF	USB Service connection not in use

Status LED 5

Not used

Power Indication

There are two LEDs on the lower edge of the module indicating the presence of the two power supply voltages (main power supply and redundant power supply).

LED 1	Indication
Green	Power from Main PSU ok
off	No power from Main Power Supply

LED 2	Indication
Green	Power from Redundant PSU ok
off	No power from Redundant PSU

PCB Front View

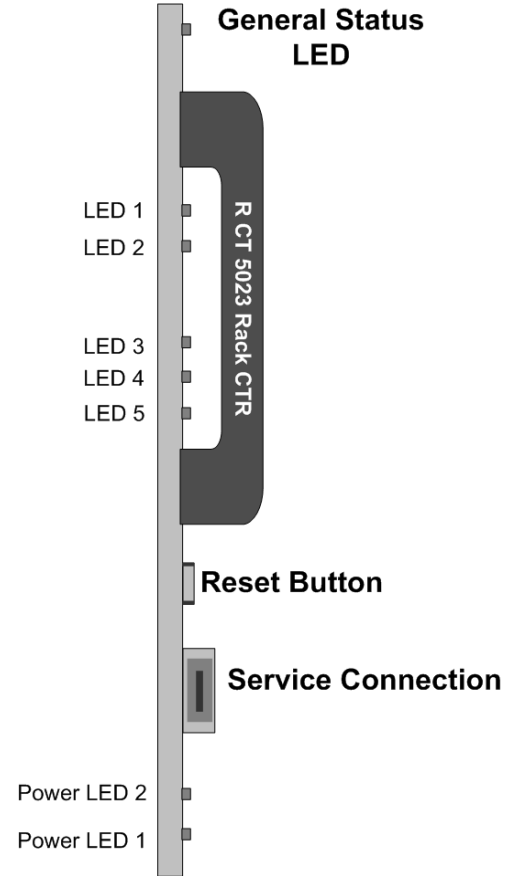

Network Configurations

How to attach a RCT 5023-G (Network Configurations Editor)

The RCT 5023-G can be attached directly to a PC or to a Master Controller (e.g. *OH_RCT5023_Server*) via the LAN connectivity.

Note: One RCT 5023-G can be attached to up to three servers at the same time.

Connect the rack frame where the RCT 5023-G is inserted through the LAN connector to the PC or the Network. The PC with the LYNX control SW has to be in the same Network (LAN). The LEDs in the LAN connector of the rack frame will show network activity if connected properly.

Open the Network Connection Management window in the GUI of the LYNX control SW by selecting it in the TAB "Tools" or by clicking on the Connect button in the Menu Bar.

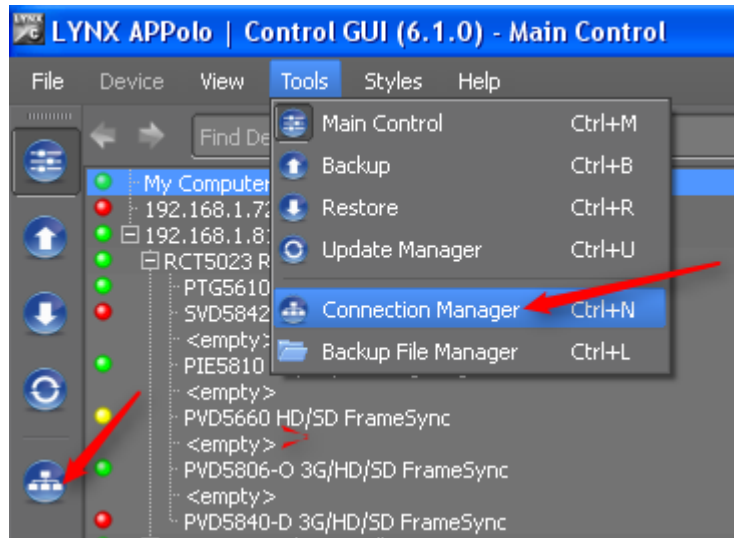

The Network Connections Management window will open then.

Select the Network Connections Editor and drag & drop the RCT 5023-G onto the PC (My Computer) or a LYNX Server (e.g. OH_RCT5023_SERVER) it should be attached to.

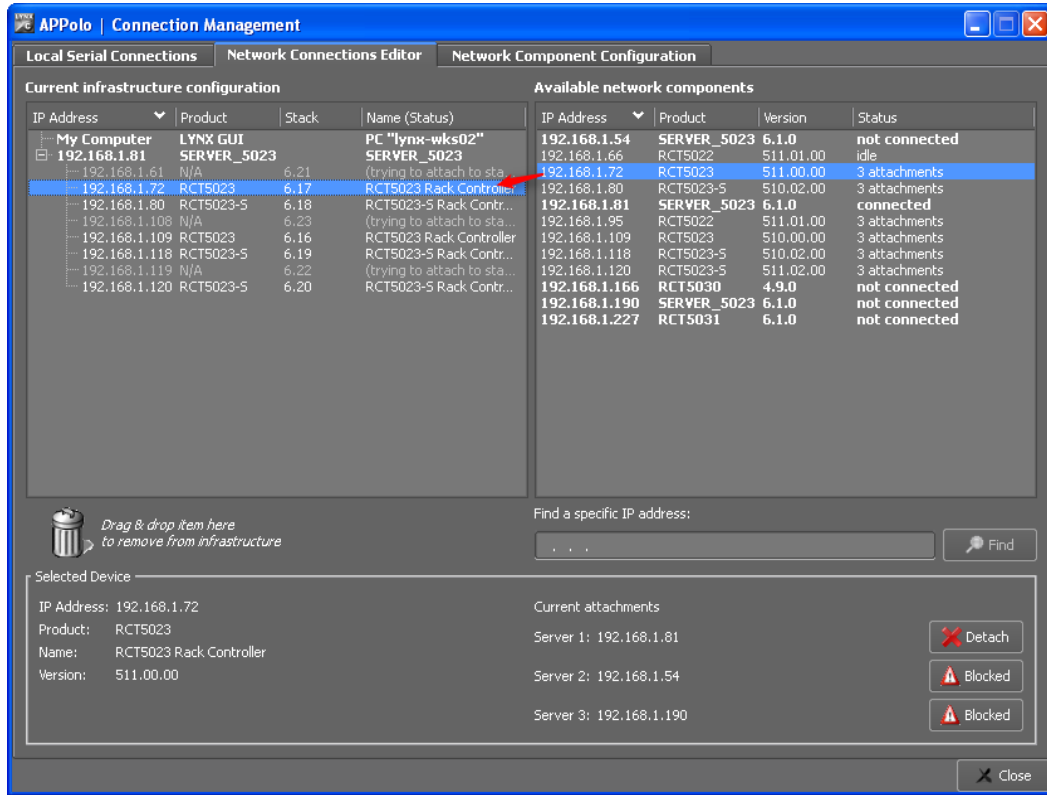

The Network Connection Management tool detects all RCT 5023-G in a connected network, independent from the IP address in the RCT 5023-G. If an RCT 5023-G has an IP address which is not valid for the connected network it still possible to attach the controller to a LYNX server, but the controller and its associated modules will not be displayed in the device tree. You can log into this controller by right-clicking on the controller “Current infrastructure configuration and select “login” in the pop-up menu.

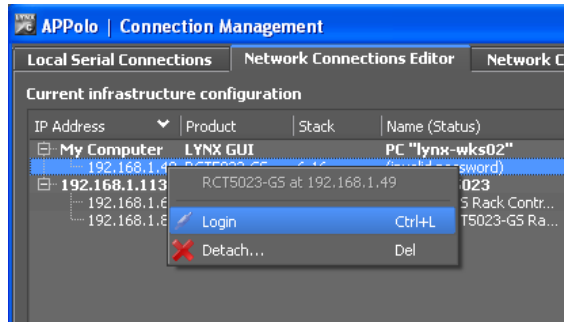

Controller Network Configuration (Network Component Configuration)

In the Network Connection Management window the IP configuration for the selected controller (Network Component) can be modified, e.g. change of IP address, activation of DHCP mode or changing passwords.

Note: Changing the settings is only allowed for the administrator.
Default password: **lynx\$admin**

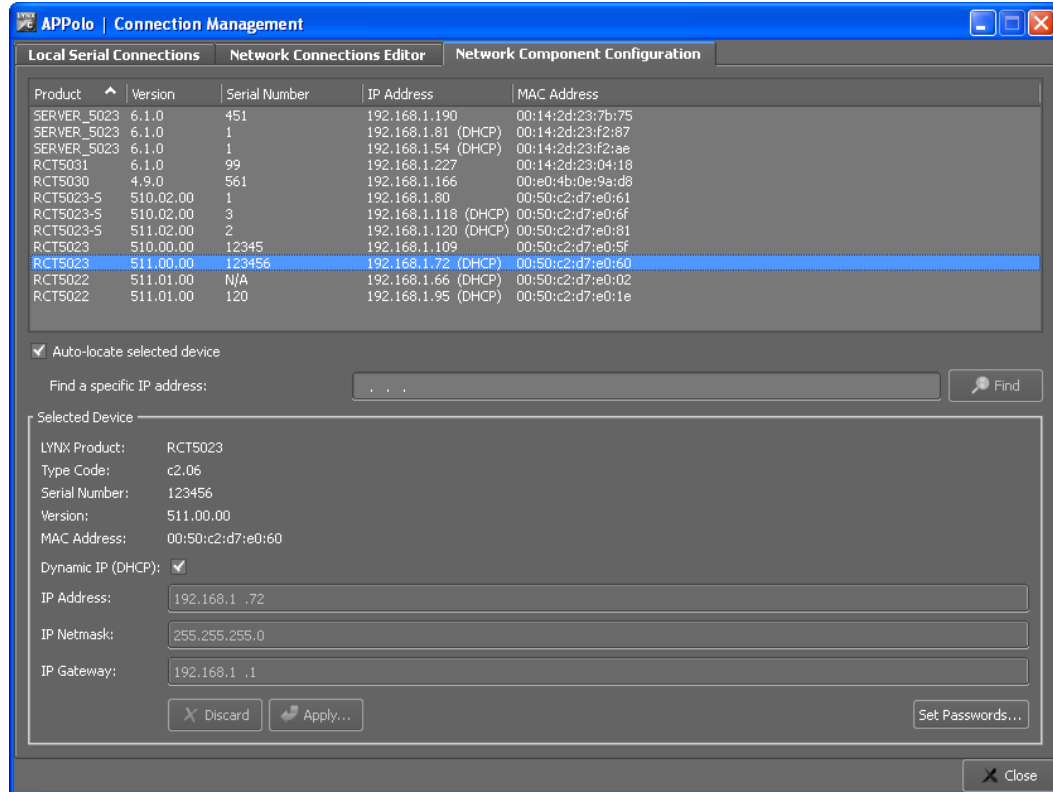

Default IP Address

The default IP Address of RCT 5023G is **192.168.1.162** and IP Netmask is **255.255.255.0**.

Setting IP Addresses

To set a dedicated IP address for the RCT 5023-G just type in the required information into the respective text fields in the Network Connection Management window shown above.

Note: DHCP mode has to be deactivated in the checkbox "Dynamic IP (DHCP)"

Activation of DHCP Mode

If the controller is installed in a network environment where the IP addresses are allocated automatically (DHCP) the RCT 5023-G can be set to DHCP mode. Simply activate the checkbox "Dynamic IP (DHCP)" in the Network Connection Management window shown above.

Note: IF in DHCP mode the controller will wait approx. 30sec for a DHCP capable server to get allocation of an IP address. If no address will be allocated by a DHCP server, the device will configure itself to a zero-conf configuration:

IP address: 169.254.x.x (x.x is arbitrary)
Netmask: 255.255.0.0
Gateway: 0.0.0.0

APPolo GUI Software

The APPolo GUI software is supplied as part of the RCT 5023-G controller package. This is supplied on CD Rom or can be downloaded from the LYNX homepage.

The Control Software is a comprehensive, centralized application which provides for the remote control / status monitoring and event (error) reporting for all modules installed in a system.

System Requirements

The control software is designed to run on a Windows compatible PC. Minimum requirements specified below

PC

IBM compatible PC, Pentium 4 class, 1GB RAM VGA Monitor, CD ROM drive

Operating System:

Microsoft Windows XP Home/Professional, Windows 7.

Software Installation

1. Close all other applications on the PC.

Insert the software CD into the CD-Rom drive. If the CD-Rom does not start automatically, start the application from the CD by clicking on:
APPoloControlGUI.xxxxxxxx.RELEASE_x.x.x.exe"

2. The following screen will display, click **Next** to continue

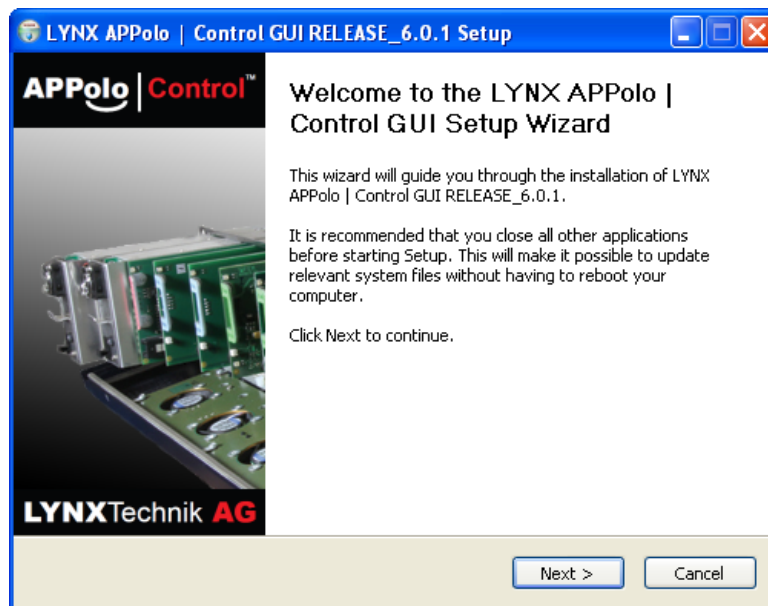

- The following screen will display, read the license agreement and click **I Agree** if acceptable.

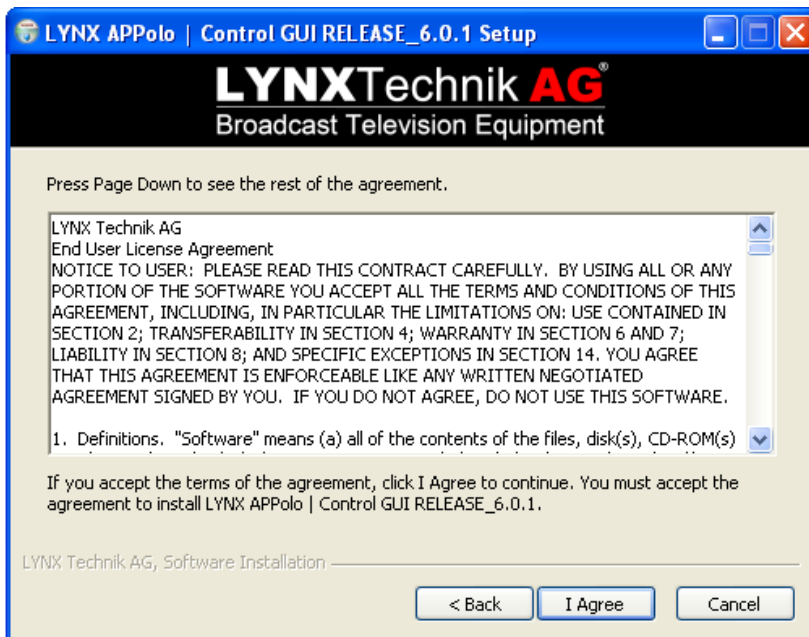

- Select the additional components and click **Next**

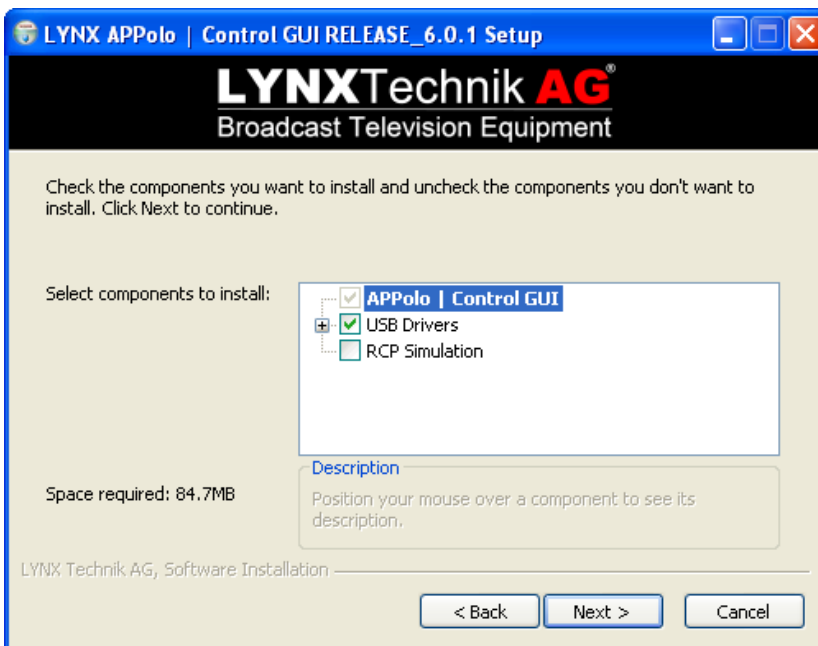

- Define the destination folder and press **Next** to install the application. You can use the proposed standard folder, which will be created automatically.



- You can select the start folder menu and you can choose if you would like an icon placed on your desktop.

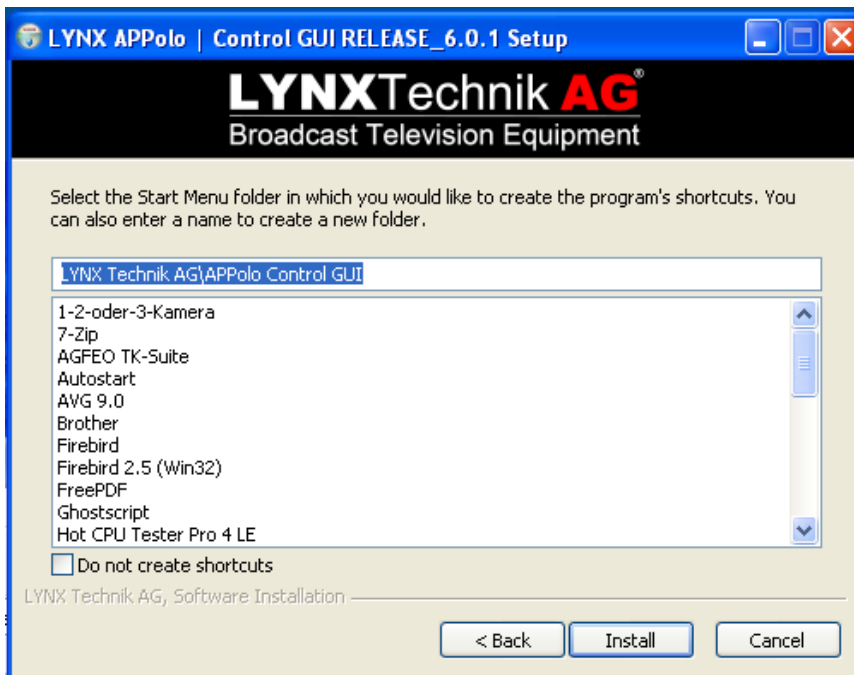

7. Installer will then start copying files to your hard drive. When finished **Finish** the Installer.

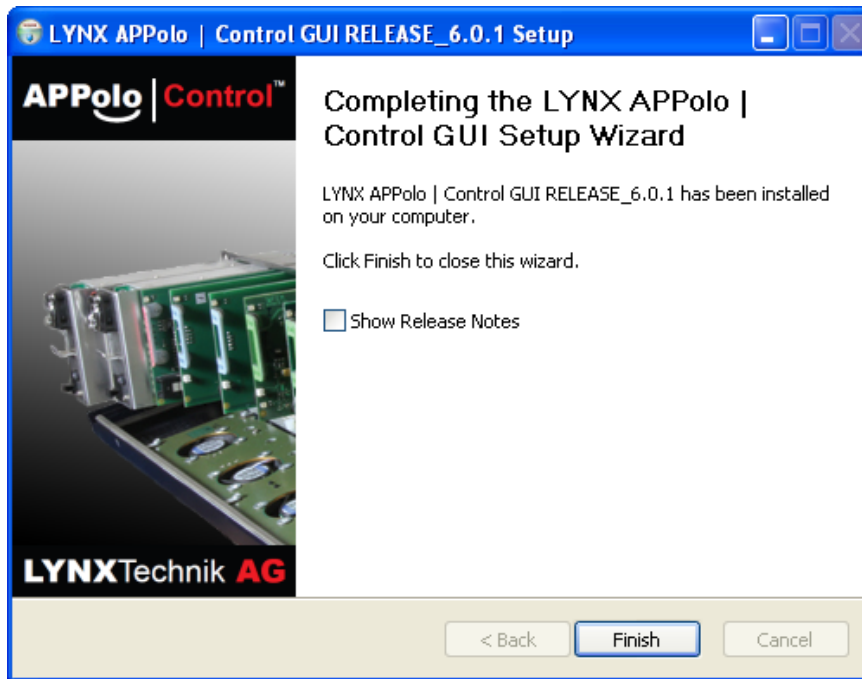

Starting the Controller Application

If you chose to install the desktop icon during installation, simply click this to start the controller application.



APPolo Control GUI Icon.

OR navigate to the lynx folder in “program files” and select **c3_local.exe**

The GUI will start and the application will firstly look for the attached controller (please see chapter “Network Configuration - How to attach a RCT 5023-G”), when found the controller will report all the attached modules into the GUI and these will displayed in the folder tree. Module detection is automatic.

If a connected RCT 5023-G is not displayed in the GUI then the software cannot find the Controller. Please check the following:

1. Make sure that the RCT 5023-G is connected to the network correctly and that there is not IP conflict.
2. Use the “Network Connections Editor” in the GUI to attach the Controller to the GUI. Please see chapter “Network Configuration - How to attach an RCT 5023-G”.

Software Updates

From time to time we update the software to add support for new modules or new features or correct bugs. Updates are supplied free of charge. You can contact us directly or check our web site (<http://download.lynx-technik.com>) for any available updates.

Software Version Number

To determine the release and version number of the software installed on your system. Pressing **F1** or selecting the **Help** drop down menu and then **About** will display the splash screen.



Reporting Problems

If you are experiencing problems with your installation please contact us for assistance. We will require a copy of the available service information (see below). We will ask you to E-Mail the generated file with a brief description of the problem and also any steps we can use to duplicate the fault. Send messages to:

Support @ lynx-technik.com

Collect Service Information

You can collect all available service information in all connected servers through the “Help” menu. Just click on “Collect Service information” and the window below will pop up.

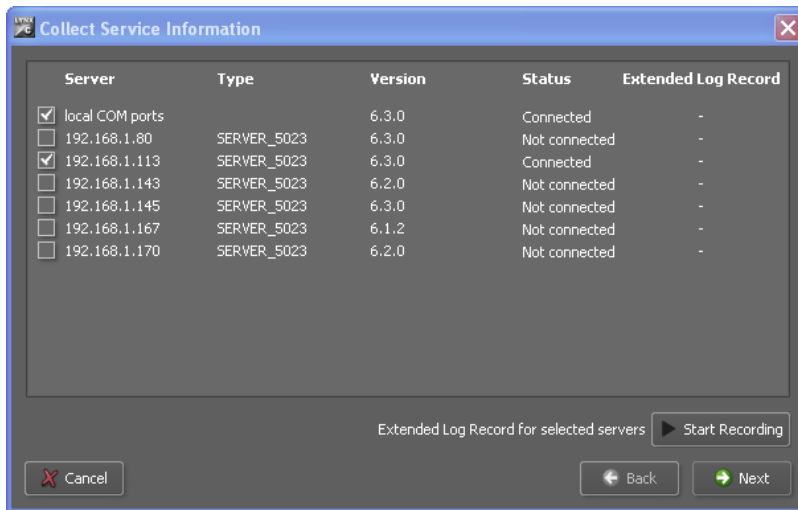
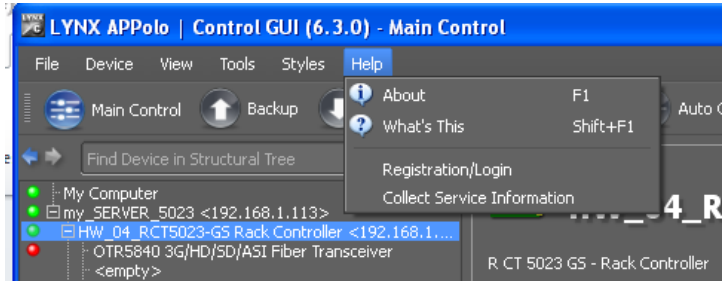

Select the servers you want to collect the logfiles from and click on “Next”

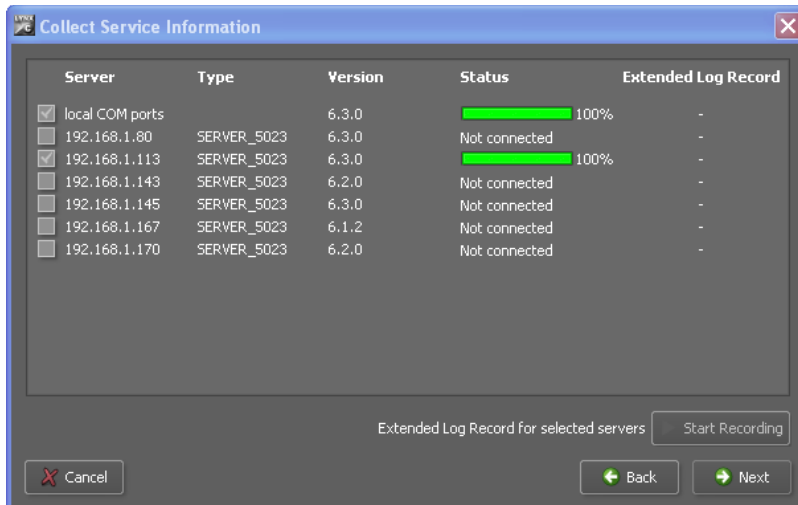

Please wait until all available data are collected. The status indication of the selected servers will turn green then.

Please fill in all requested data (fields marked in red are mandatory) and click "Next".

The information will be stored in the selected directory.

If, for any reason, you cannot run the APPolo GUI SW on your computer you can also find the logfile on your computer.

We will require a copy of this file that is stored by the system that can be found in the directory:

WinXP German:

"C:\Dokumente und Einstellungen\All Users\Anwendungsdaten\Lynx\c3_local"

WinXP English:

"C:\Documents and Settings\All Users\Application Data\Lynx\c3_local"

Win7: "C:\ProgramData\Lynx\c3_local"

Note. *These directories are normally hidden directories.*

The file is called **c3_local.logfile.txt**. We will ask you to E-Mail this file with a brief description of the problem and also any steps we can use to duplicate the fault. Send messages to:

Support @ lynx-technik.com

Software Operation

The LYNX Control Software is intuitive and simple to use, presented in a familiar Windows style layout. It is beyond the scope of this manual to provide detail on each individual control available for all supported modules, please see in the manuals of the individual modules. This is intended as an introduction to the general layout and the use of the control GUI.

Control System Layout

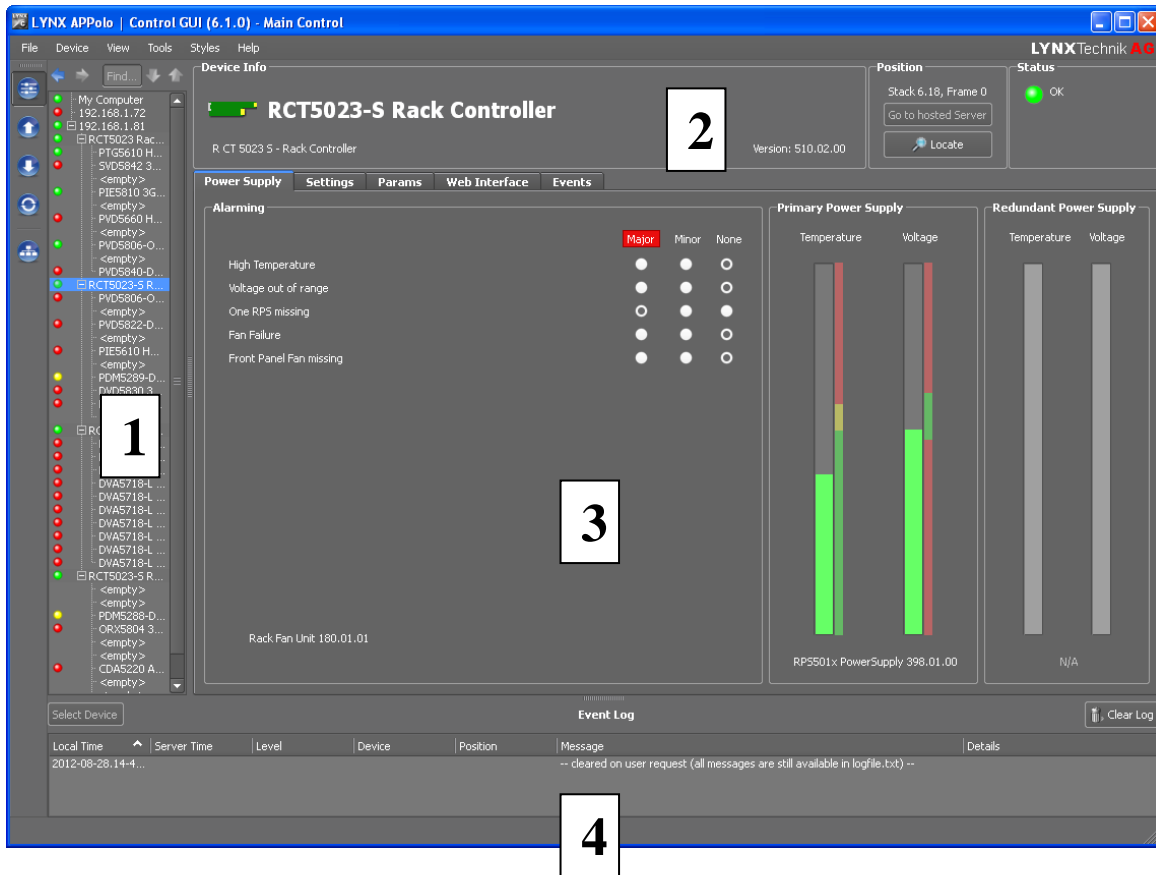

The above screenshot shows the normal layout of the control system GUI. The descriptions below provide more detail on each section of the GUI and its operation.

Device List

1 This area is organized like a standard windows folder tree and is where all controllers and modules detected by the system are displayed. The modules attached are arranged under each controller.

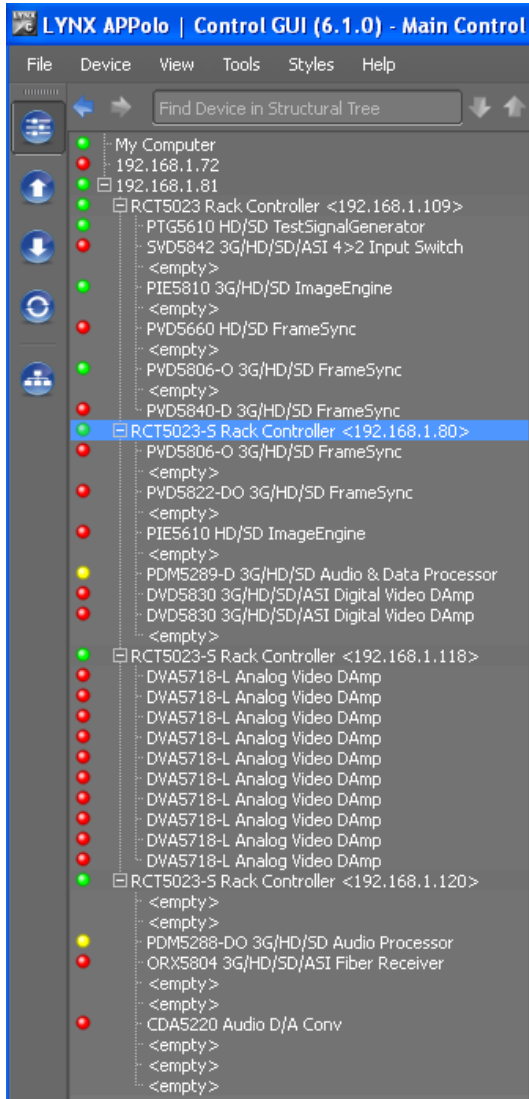

- Clicking on any device in the tree will display the associated GUI for control of this device. Next to each device there is a small colored dot. This is a graphic representation of the Alarm LED next to each module listed for easy identification of problems within the system.

- Levels can be collapsed and expanded so only the information required is displayed in the folder tree. This is useful for systems with a large number of racks and modules.

Note. Indication of empty slots can be switched ON and OFF in the “View” menu

- If a module is removed or added to the system then this will be detected automatically and added / removed from the folder tree. This also triggers an event in the event log (5) to indicate when this change was made to the system.

- By clicking with the right mouse button on the selected module a pop up window with additional controls for the selected module will be shown.

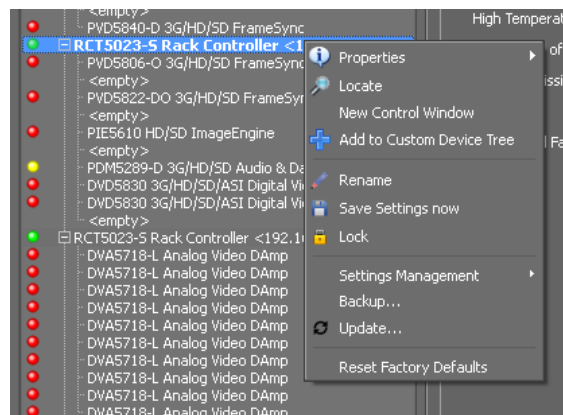

User Defined Device List

A Custom Device Tree can be created by each user.

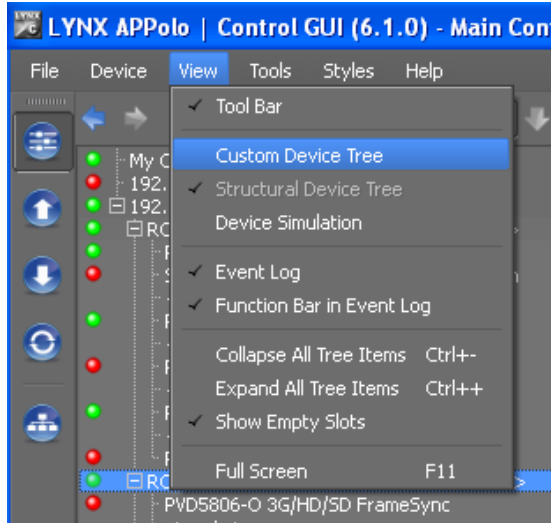

Select the Custom Device Tree in the TAB "View".

A second list, which can be edited, will show up.

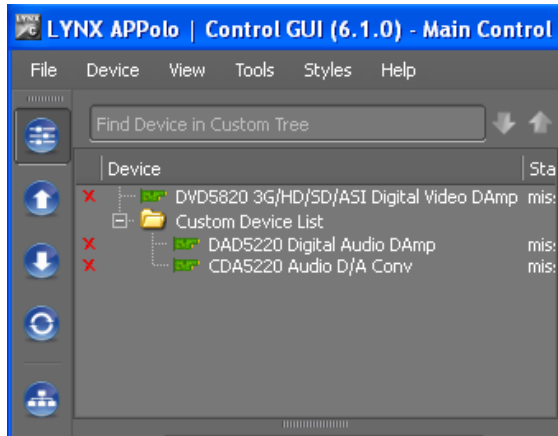

Select "Edit" mode, then you can drag&drop devices from the standard device list to the user defined device list, create own groups etc.

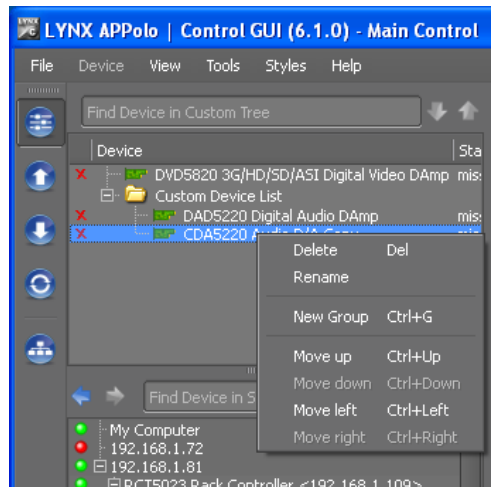

Module Properties

- Selecting **Properties** will give additional information about the module. This is information which is also important in case of service issues

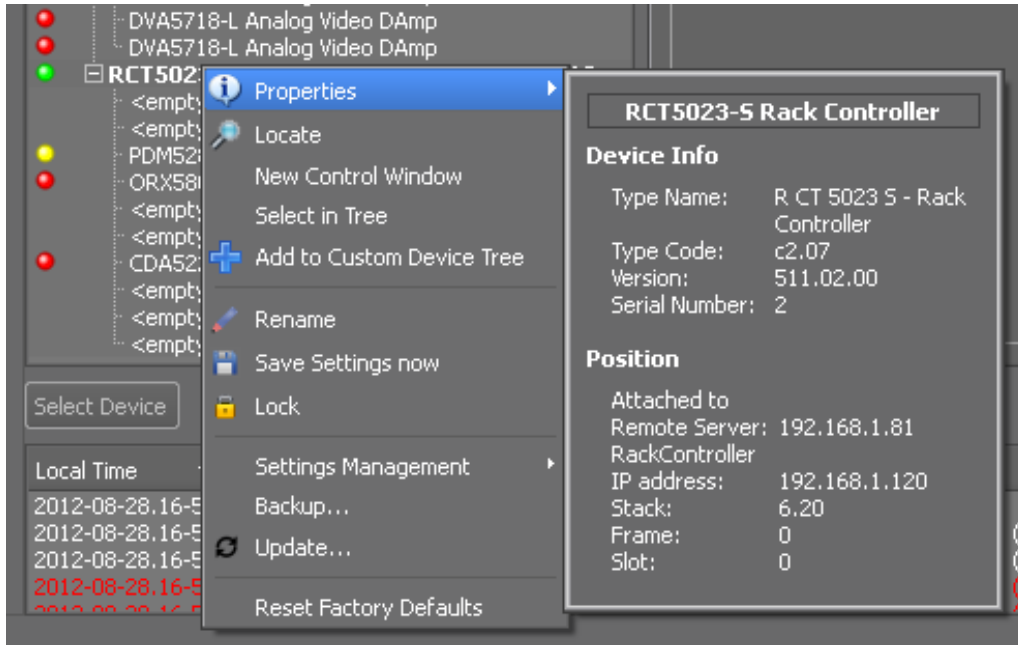

- The **Locate** function is described below

New Control Window

- **New Control Window** opens another window for control of the selected module. With this function several control windows can be opened simultaneously showing various control tabs.

Module Rename

- **Rename** allows to change any module name with a user defined description

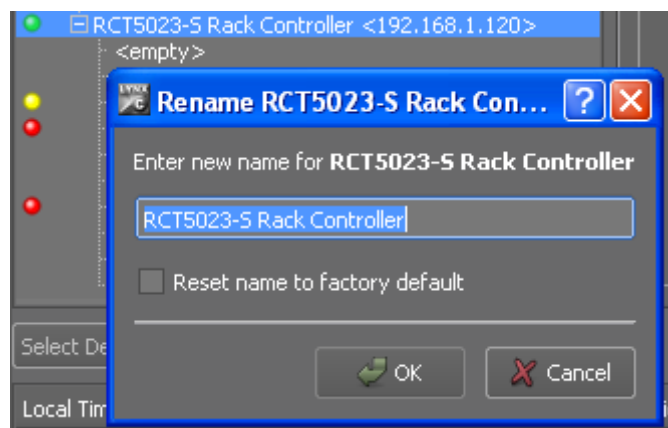

- **Save Settings Now** will force the module to store all current settings to be written into the on-board Flash memory

Note: After changing any parameter the module will write the changes to the Flash memory automatically after 10 seconds

- To avoid any unwanted changes of settings all controls of the selected card can be locked. All control elements of this card will be greyed out then.

- If at any time it is necessary to return the module to the factory default settings this can be done using the “**Restore Factory Default**” function. You will be prompted if you are sure, as this will erase any stored information from the module flash ram and set it back to the factory settings.

Note: *The IP address and the Admin password of the RCT 5023-G will not be affected. These two parameters can only be reset by pressing the reset button at the card front edge for more than 5 seconds*



- **Simulation** is only active when the simulation mode of APPolo Control GUI is selected. This can be done in the Tab “Local Serial Connectors” in the Connection Manager or in the Tab “View” on top of the APPolo Control GUI.

Module Title Area

- 2** This is the main title area where the description of the module can be found as well as details on its physical location in the system (Rack number and Rack Slot)

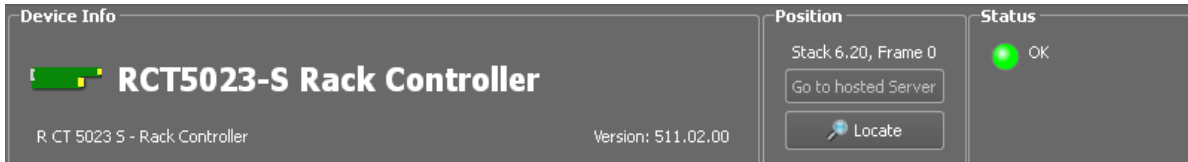

This area also displays the status of the module and describes any reported event next to the colored dot (which is also a mirror of the module LED)

Locate Function

For larger systems which may have multiple cards of the same type in a single rack, or multiple racks in a larger system we have added a useful utility which will help to physically locate a suspect module in a rack quickly.

When Locate is selected the status indicator on the GUI and the alarm LED will flash yellow in the following continuous sequence.

3 short flashes.... Pause.... 3 short flashes ...

The LED continues to flash in this way until the function is turned off in the GUI.

Use of the locate function will not interfere with the normal operation of the module.

Control Tabs

- 3** This is the main control area for the module and changes depending on which module is selected in the folder tree. This area has several tabs that will take you into different areas of control for the Module. The number of tabs will vary depending on the type of module, for the controller you find **Power Supply – Settings – Options – Params – Events**



Power Supply Tab

Power Supply. This tab is the default display and brings up the primary controls for the controller.

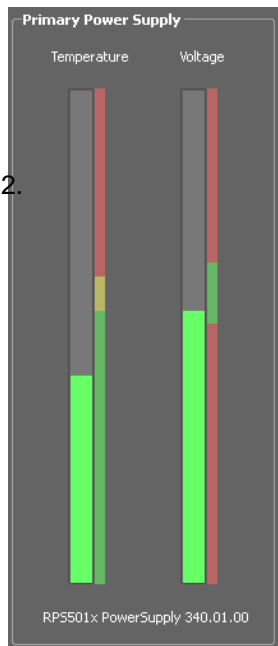

- It shows the status of the power supply voltage as well as the rack temperature

- Alarms (two levels) for different failure modes in the rack frame can be set for triggering of the Alarm contacts. The Alarm contacts will be closed permanently as long as the alarm state is active. See page 12 for the location of the contacts on the rear termination panel of the rack frame

Alarming			
	Major	Minor	None
High Temperature	<input checked="" type="radio"/>	<input type="radio"/>	<input type="radio"/>
Voltage out of range	<input checked="" type="radio"/>	<input type="radio"/>	<input type="radio"/>
One RPS missing	<input type="radio"/>	<input checked="" type="radio"/>	<input type="radio"/>
Fan Failure	<input checked="" type="radio"/>	<input type="radio"/>	<input type="radio"/>
Front Panel Fan missing	<input checked="" type="radio"/>	<input type="radio"/>	<input type="radio"/>

Settings Tab

Settings. This tab allows for the activation of the function **Hotsync Backup** and the setting of the **IP address**

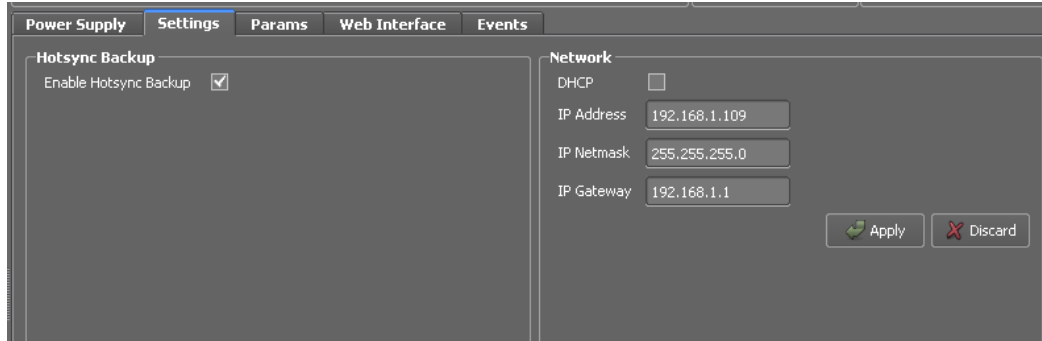

Hotsync

Hotsync is a feature built into the control system that is a way for all module settings and configurations to be stored in the RCT 5023-G Controller. Currently all module settings are stored in Flash Ram within the module which survive module removal / power cycles and even long term storage. The Hotsync function supplements this with another level of convenience.

Once enabled Hotsync will remember all the settings and configurations for all modules installed in a Series 5000 Rack. This way when a defective module is “hot swapped” the settings that were previously used are written into the new module. No switches to set, nothing to calibrate, plug and play convenience.

The Hotsync function is totally automatic and runs in the background. This function requires no user intervention once enabled in the GUI.

NOTE: *Hotsync is only available for Series 5000, modules of Series 3000 are not supported*

Switching on Hotsync

The Hotsync function is off by default and needs to be enabled in the control system GUI. Highlight the RCT 5023-G in the folder tree and select the “Settings” tab. Here you will see a checkbox to turn this function ON or OFF.

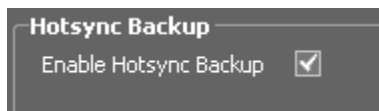

Note. The Hotsync function is specific to each RCT 5023-G controller and will need to be enabled for each controller of this type used in your system.

Hotsync Function

The Hotsync function has useful applications and below describes how the system works under various situations

Board failure “Hot Swap”

Typically when a failure occurs it is important to get the system back online as quickly as possible. Some LYNX modules are complex and have a lot of user settings and configurations that have been set for the specific application. Having to manually reset all the parameters in the new card can be time consuming and prone to errors. Hotsync takes care of this automatically. When the system detects a hot swap of a particular card, Hotsync will automatically restore all the previously used settings into the new module. This process is automatic and takes a couple of seconds.

Note. A card of the same type must be exchanged in the same slot for HotSync to function correctly.

System Changes

During normal operation the settings in the system can be changed or tweaked over time. Hotsync detects these changes when made and will automatically sync the revised module data into its local memory. At all times the Hotsync stored data is 100% – no user intervention is required.

System Expansion

There are times when additional modules are added to a system during system expansion. Hotsync will detect any additions and automatically register the new hardware and store the settings – no user intervention is required.

Note. After a power cycle the Hotsync function will not be functional for 15 seconds. Any modules hot swapped in this period will not be restored with the previous settings; the specific module settings will be used.

Hotsync Indications

Once the Hotsync function is enabled the process is fully automatic. There are some indicators on the RCT 5023-G Controller card that indicate status.

PCB Front View

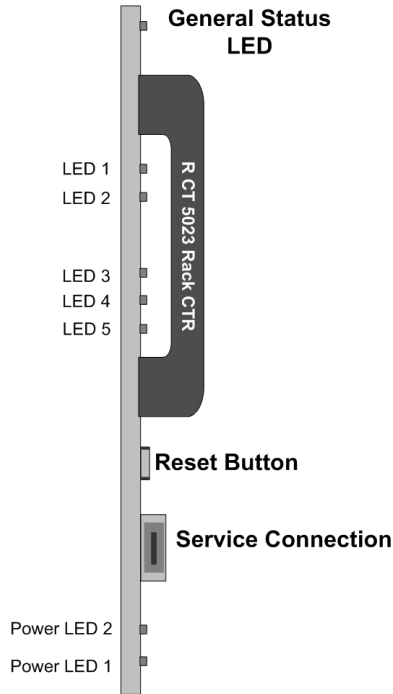

Hotsync RESTORE – LED 1

This LED is illuminated when Hotsync is switched ON. When Hotsync is restoring data to a module this LED will turn yellow. If Hotsync is deactivated this LED is OFF.

Hotsync SAVE – LED 2

This LED is illuminated when Hotsync is switched ON. When Hotsync is saving data from a module this LED will turn yellow. If Hotsync is deactivated this LED is OFF.

Note

Hotsync is a utility designed to automatically maintain a system which is switched on and operational and makes the assumption that any hardware which is inserted into the system will need the settings restored back into the new module. If there is ever the situation where you would like to replace a card but retain the settings stored in this card then please follow the procedure below.

1. Observe **LED 1 and LED 2** on the RCT 5023-G Controller, if ON Hotsync is enabled. Disable this function in the GUI and confirm this LED is **OFF**
2. Install the new card (hot plug – no need to power down)
3. Switch Hotsync back on using the GUI, **LED 1 and LED 2** will switch back ON
4. The setting stored within the new module will be preserved and will automatically Hotsync into the backup file.

Note.

Some older Series 5000 cards will not **support the new Hotsync feature. Modules that are not supported are identified in the GUI when the Hotsync function is enabled.**

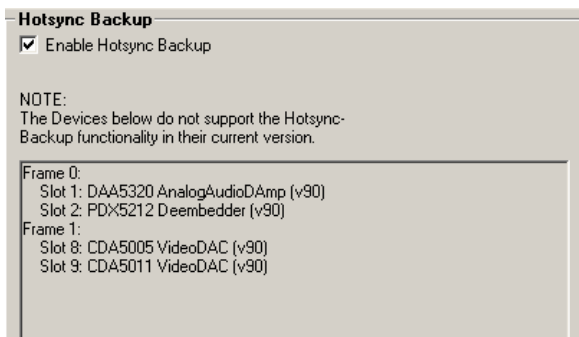

Any modules identified will require re-programming with the latest revision of firmware so this feature is supported. Please contact your authorized dealer or LYNX Technik directly for further assistance.

Network

Here you can set the IP Address, IP Netmask and IP Gateway for the selected RCT 5023-G.

A check box for DHCP mode is also provided. Activating the checkbox will enable the DHCP mode.

The screenshot shows a 'Network' configuration window. At the top left is the title 'Network'. Below it is a 'DHCP' checkbox which is currently unchecked. Underneath are three input fields: 'IP Address' containing '192.168.1.109', 'IP Netmask' containing '255.255.255.0', and 'IP Gateway' containing '192.168.1.1'. At the bottom right of the window are two buttons: 'Apply' with a green checkmark icon and 'Discard' with a red X icon.

A new setting will be activated by clicking on the **Apply** button. Any changed setting can be ignored by

clicking on the **Discard** button.

Web Interface Tab

This Tab allows for administration of users (login and password) and system settings

The screenshot shows the 'Web Interface' tab of the RCT5023 control system. The top navigation bar includes 'Power Supply', 'Settings', 'Params', 'Web Interface' (selected), and 'Events'. The main header displays 'RCT5023' and 'LYNXTechnikAG® Broadcast Television Equipment'. On the left, a vertical menu shows 'Login' (selected), 'System', 'User Management', and 'System Setup'. The 'Login' section displays 'FW version: 511' and has input fields for 'Login:' (with 'admin' entered) and 'Password:'. A 'Log in' button is located below the password field.

Only the administrator can log in. The default administrator password is:
lynx\$admin

Note: This Interface is also available as HTTP web-interface in a regular web browser.

Events Tab

The Events Tab is where event notifications are configured for the module.

The GUI has an integrated event log, which is a simple text log file stored in the controller PC. This will record an event and timestamp it. The log can be seen at the bottom of the GUI screen and can be scrolled through using the scrolling bar. Events are always logged into c3_local.logfile.txt. The checkboxes (see screenshot below) enable or disable the display of event messages to the GUI log window (see right: Event Logging Area), saving to the logfile cannot be disabled.

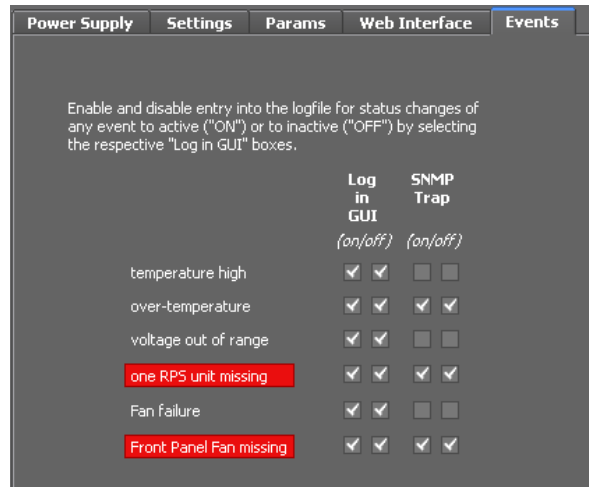

Log in GUI Function

Events are selectable, you can chose if you want to record a particular event in the log (or not) or configure it to only record one side of the event. (For example you might want to log when a power supply is missing but do not want to log when it came back). The ON/OFF trigger can be configured for each of the available events shown in the list and is setup using the checkboxes provided.

SNMP Support

If the system is using a Master Controller Option (e.g. OH_RCT5023_Server) and the SNMP option is installed then the “SNMP Trap” columns become available.

Here you can configure what events you would like to transmit an “SNMP trap” over the network. (This has no impact or influence over the internally eventlog maintained by the LYNX control system)

(Internal LYNX event logging and external SNMP traps can be configured independently).

Event Logging Area

4

This is the event logging area of the GUI and is the central repository of all events encountered by the system.

Note. The messages in the log window can be erased, but a log file is stored in the PC not the individual modules. Each time an event condition is encountered and entry is automatically made in the log. All entries are time stamped and can be sorted through a filter with different selections

Update Manager

The Update Manager allows for updates of connected modules and the RCT 5023-G itself through the APPolo Control GUI SW.

Registration

This function is only active in case you are a registered user of the APPolo Desktop Controller SW.

For Registration please select **Registration/Login** in the TAB Help.

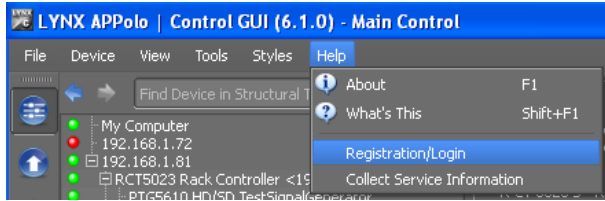

The following screen will be shown:

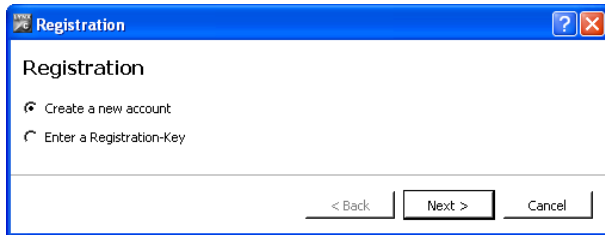

If you have Registration Key already please select **Enter a Registration-Key**

Enter the required data and **Save**. You will receive an acknowledgement e-mail on the account you typed in.

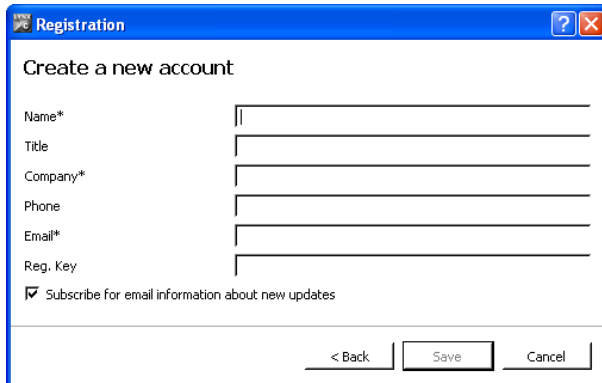

After you received an e-mail from LYNX Support with your login and key information you can activate your account..

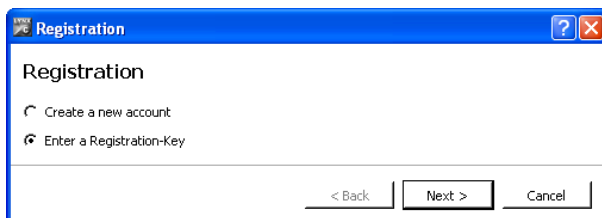

Click on **Next** and the following screen will be shown. Type in the required data and **Save**. The application has to be restarted to activate the Update Manager, If done you can select the Update manager in TAB Tools or on the Main Program Bar.

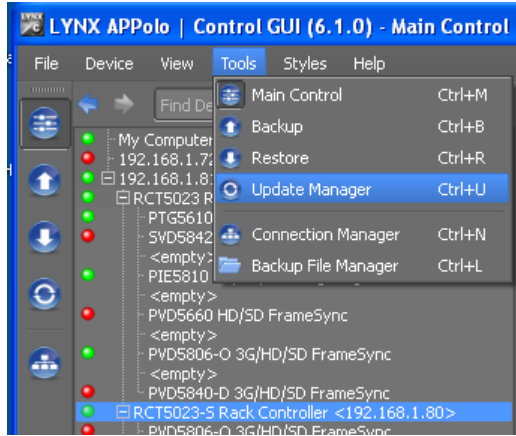

Update Tab

This Tab shows all connected devices for selection in the Update manager. In the list you can see the respective, installed SW Versions and also the recommended version for update. In case there is a newer version available a blue, circled "I" will be shown.

Please select the modules you would like to update and click on **Start Update**

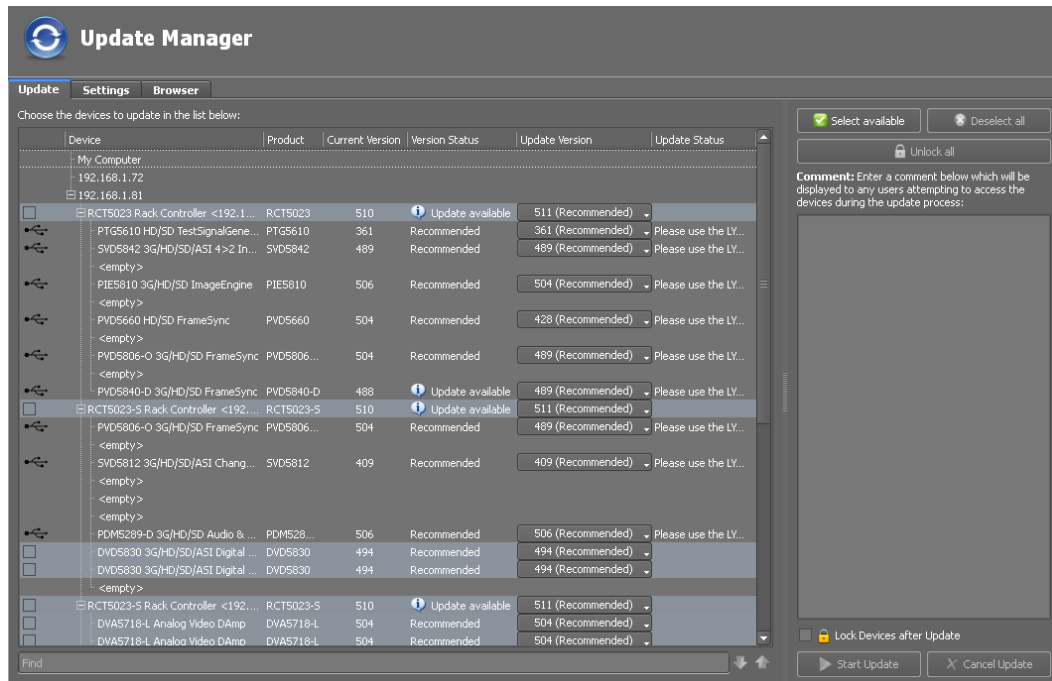

In case the update is not yet possible for the selected module you can use the LYNX USB programming device instead, which has to be connected directly to the module.

A comment for other users, which will be shown during the update process (module is locked then), can be inserted into the text field on the right side of this tab.

Note: If the RCT 5023-G is attached to a LYNX Server the version of the embedded SW of the Server has to be 6.3.0 or higher

Settings Tab

Here you can define the synchronization of update data with the LYNX Server

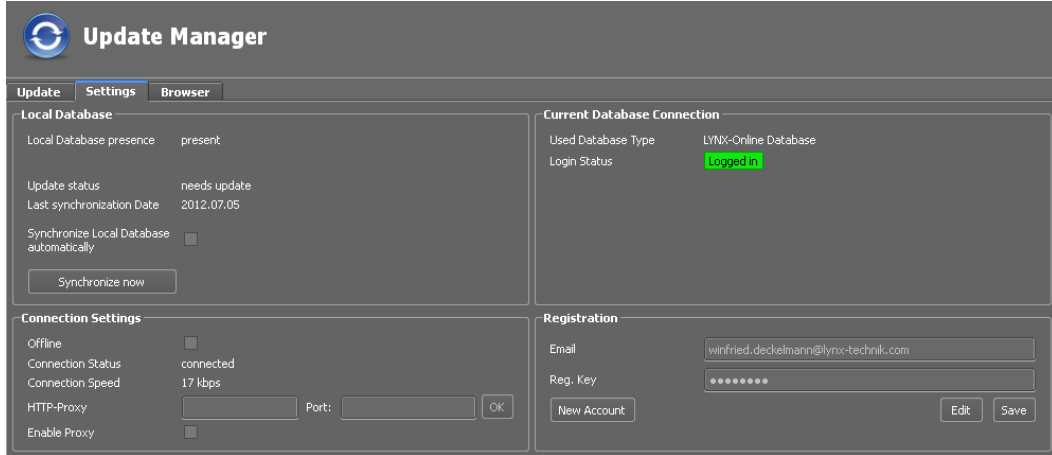

If you would like to avoid automatic connection to the LYNX Server please activate the checkbox at the bottom of the screen (“Offline”).

You can synchronize your local data by clicking on the **Synchronize Now** button or activating the checkbox **“Synchronize Local Database automatically”**

Browser Tab

In this tab the content of the local data base can be viewed including release notes.

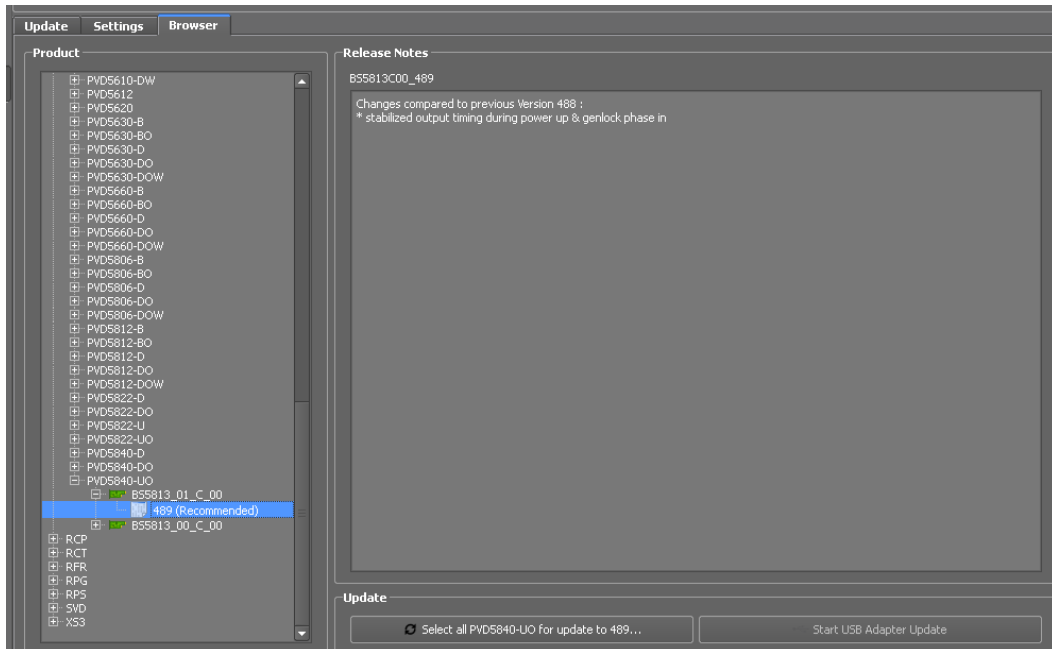

If you opened a specific version you can select all connected modules for this type of SW/FW. Just click on the left button at the bottom.

In case the module does not support programming through the control system, a USB programming adapter can be connected and the module can be programmed through this adapter.

Manual Database Installation

It is possible to install the local database manually, in other words without the synchronize process on the settings tab, which requires an active internet connection for the PC running the APPolo Software.

If you click onto the following link, you will be directed to the LYNX Technik programmer download area. (<http://download.lynx-technik.com/public/programmer/>) Select the most current version of the "SetupAPPoloControlProgrammerDatabase.201x.xx.xx.exe"-file and store it.

To install the database on the PC running the APPolo software, copy the file to this PC and execute it (for example by double click). The program will automatically install the database in the correct position for the APPolo GUI software to use it.

Server Option (OH_RCT5023_Server)

The RCT 5023-G controller board can host a LYNX Server option (OH_RCT5023_Server).

This option uses the same connector (RJ45) as the host RCT5023 rack controller to connect to a LYNX Series 5000 system through a LAN.

Installation

If this option (OH_RCT5023_Server) was supplied as part of a system it is already installed on RCT 5023-G module. If the module was supplied as a field upgrade please follow the installation procedure below.



NOTE Observe static precautions when handling card. Please see ESD warnings on Page 5.

This option consists of two components: a plug-in PC board and a battery

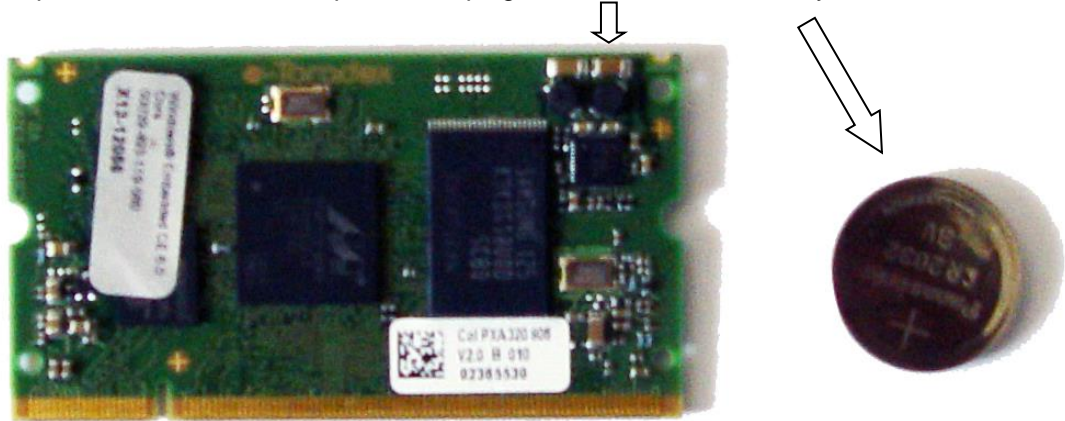

1. Slide the plug-in PC card into the connector on the RCT 5023-G module as shown below. The card should fit easily and should not require excessive force to insert. **Do not** try and force the connection this may damage the connectors.

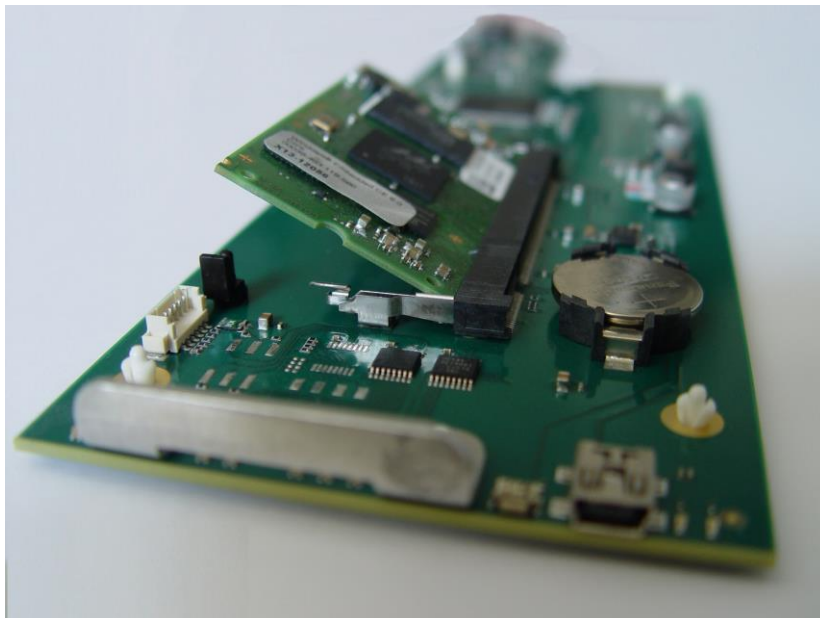

2. Push down the card and makes sure the card is securely locked into the two locking pins on both sides (4 locking pins in total)

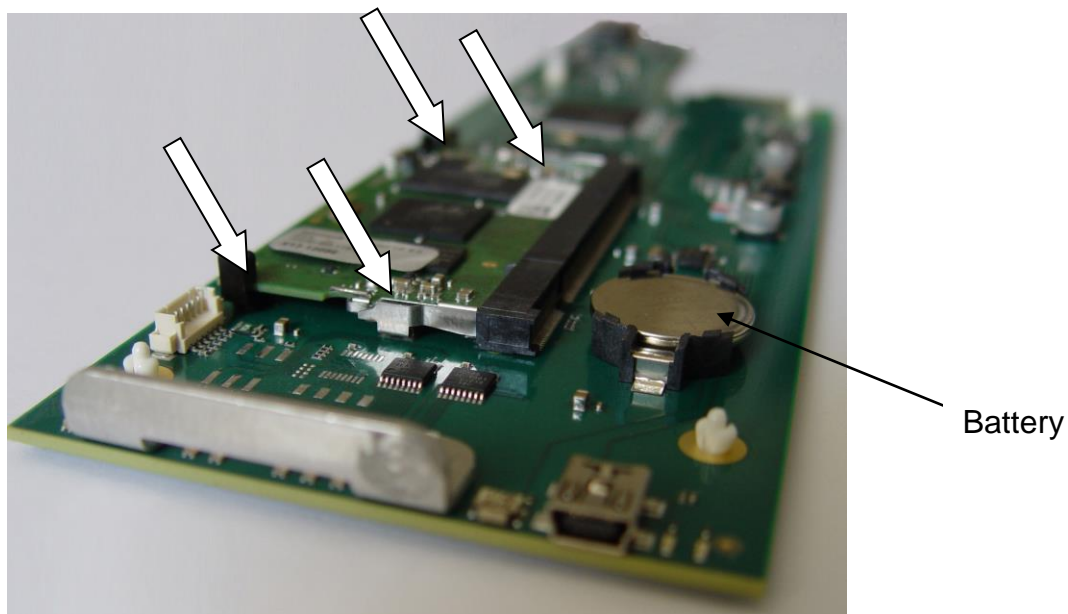

3. Insert the battery into the battery holder on the RCT 5023-G module

NOTE. The use of the optional control system is **mandatory** for the control and setup of this option. If you do not have the control system, then please contact your LYNX representative for details on how to upgrade your rack with the LYNX control system.

E.g. the control system has to be used to set the internal clock and date of the SERVER. This clock requires the battery to run, and therefore has to be set after the battery has been inserted.

Control Tabs

The OH_RCT5023 Server option requires its own IP address and is functionally independent from the host RCT 5023-G rack controller card.

If this server option is installed on a RCT 5023-G controller board the RCT 5023-G Rack Controller gets an indication in the device list of the GUI. A “-S” appendix is added to the device name in the device list of the GUI indicating that this RCT 5023-G hosts a Server option.

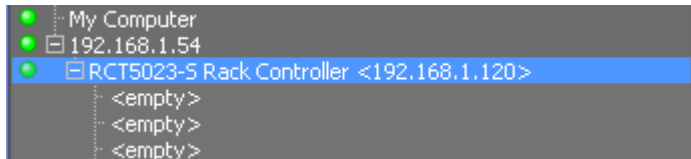

The Settings Tab of the RCT 5023-G-S Rack Controller will show additional information. The network address settings of the hosted server is also possible form this tab then.

Through the “Go to hosted Server” button above the “Locate” button you are directed to the Server page in the GUI.

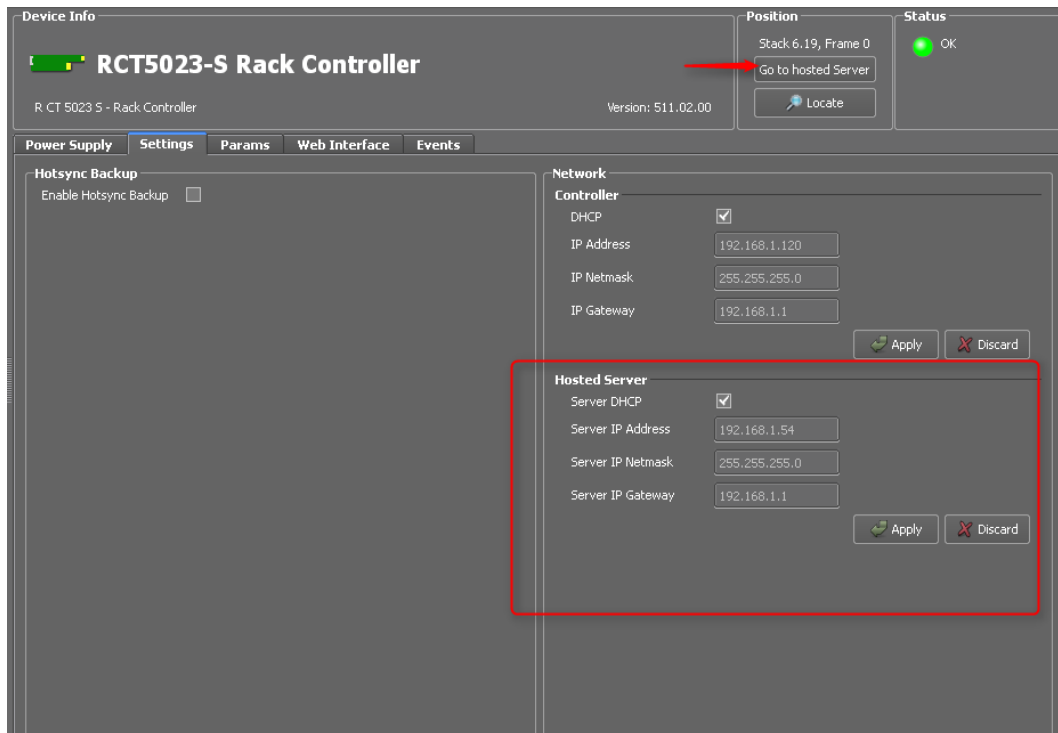

Connection Tab

In the connection tab the basic information about the LYNX Server is shown.

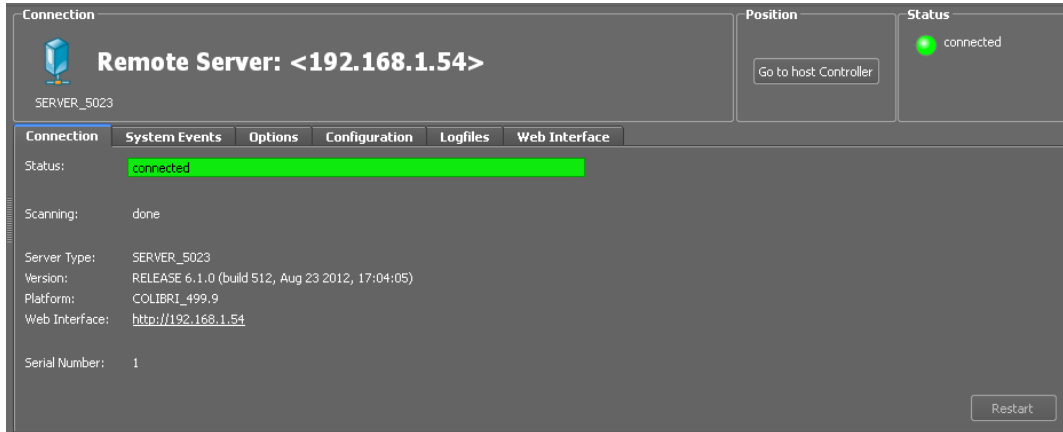

System Events Tab

Through the tab “System Events” general, system related alarm messages can be enabled.

The GUI has an integrated event log, which is a simple text log file stored in the controller PC. This will record an event and timestamp it. The log can be seen at the bottom of the GUI screen and can be scrolled through using the scrolling bar.

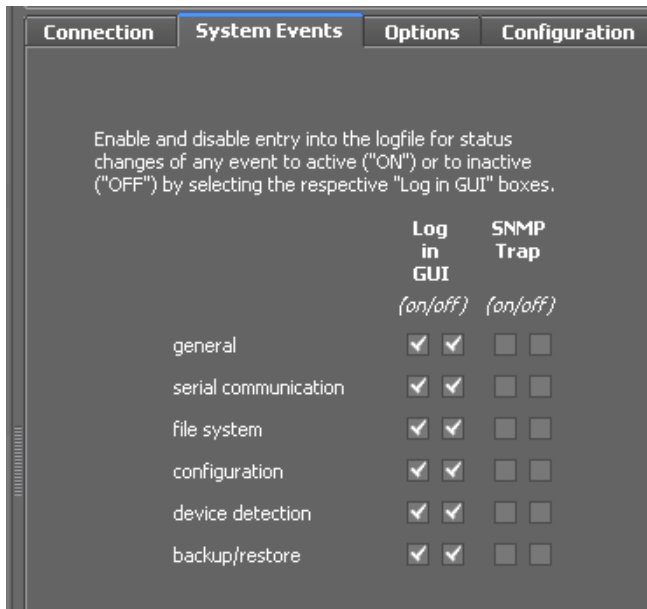

Options Tab

One tab on the GUI is reserved for “Options“. This is where the option license codes are entered to unlock the embedded firmware options.

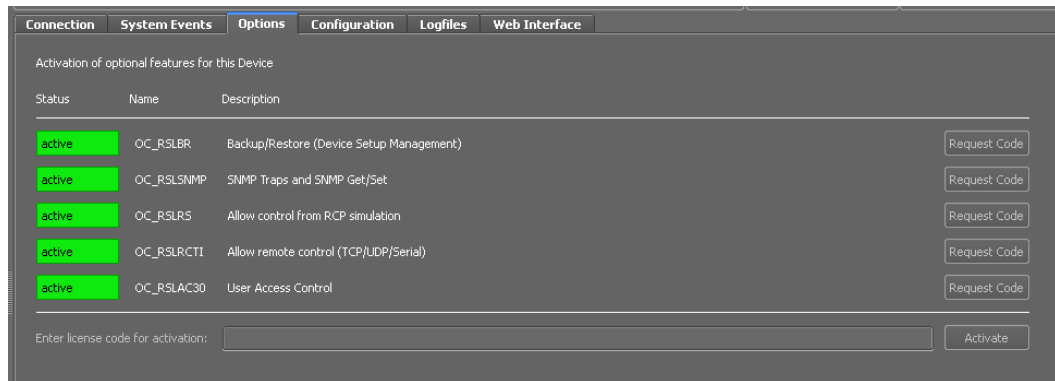

If the module was purchased with options pre-installed then you will see the option status as green (Active).

If you would like to add any option after delivery, then you will need to purchase the specific license codes from LYNX Technik.

Click the “request code” button next to the channel you wish to activate. A number will be displayed, Please forward this number with your purchase order to your authorized LYNX dealer or representative. When you receive the license string simply type it (or paste it using the windows clipboard) into the area provided and press “activate”.

Activation is confirmed when the option status turns green.

Logfiles Tab

Event log files are stored on the RCT 5023-G_Server directly. Access to the log files is possible through the tab “Logfiles”

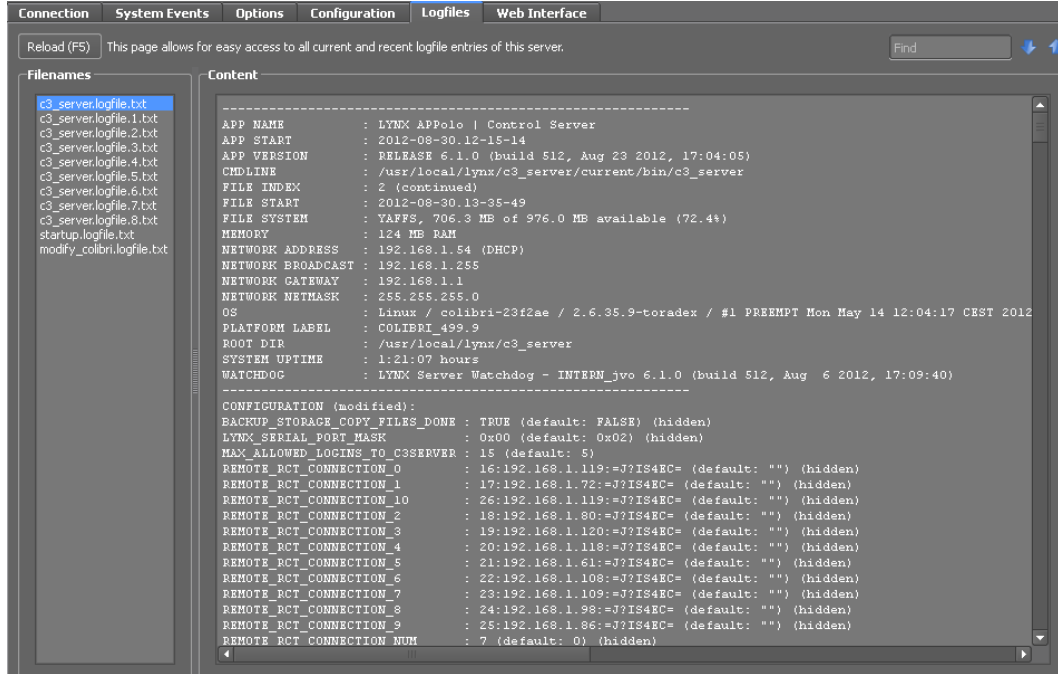

Web Interface Tab

Through this tab you can get access to administrative settings. Details see below in the Chapter “Web Interface for Option OH_RCT5023_Server”

Web Interface for Option OH_RCT5023_Server

The RCT 5023-G_Server can be setup via a web interface. Simply establish a connection between the Server and your PC. Open a Web Browser and enter the IP address of the Server. After a short while you will see the login area of the web interface.

Enter you administrator login (default: admin) and password (default: lynx\$admin) and press “Log in”.

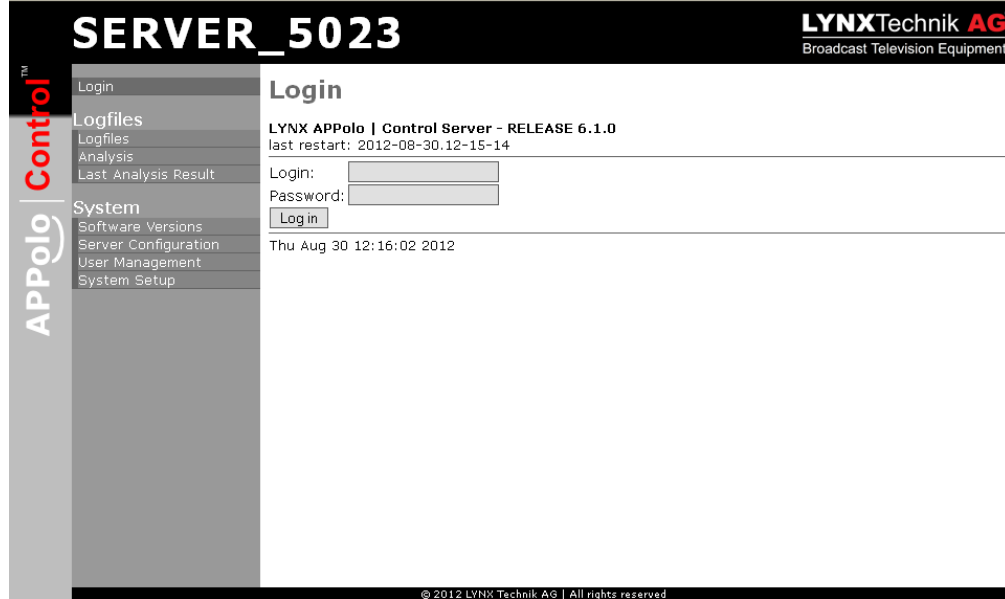

On the left side of the Web interface is the menu. Select logfiles to review the recorded logfiles.

On the “Software Version” page you can upload, activate and delete software versions for the bluBox Shufflemax. Updates can be downloaded from the LYNX Technik AG homepage (<http://download.lynx-technik.com>).

Under “User Management” you can manage the user accounts for the system access. In other words you can add users, change existing user names and/or passwords.

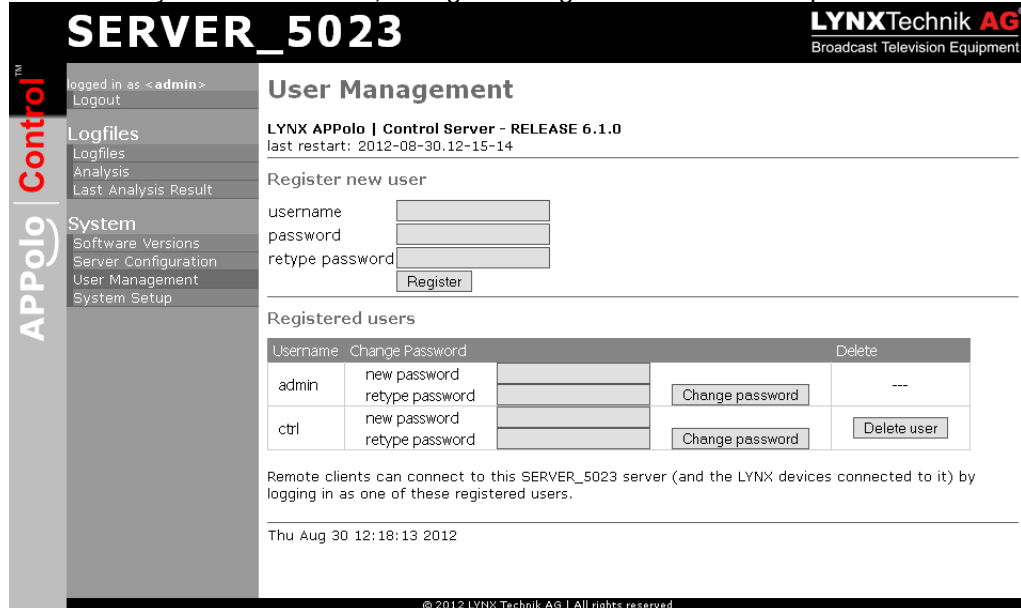

The “System Setup” page is another way (in addition to the local control panel and the APPolo Connection Manager) of setting the IP settings of the LYNX Server.

SERVER_5023 **LYNX**Technik **AG**
Broadcast Television Equipment

logged in as <admin>
Logout

Control

Logfiles
Logfiles
Analysis
Last Analysis Result

APPolo

System
Software Versions
Server Configuration
User Management
System Setup

System Setup

LYNX APPolo | Control Server - RELEASE 6.1.0
last restart: 2012-08-30.12-15-14

Network Configuration

IP Address:
 Netmask:
 Gateway:

Miscellaneous

System Time:
(Format: YYYY/MM/DD hh:mm:ss)
 Explicit restart of LYNX server applications

System Info

Device type: OH_RCT5023_SERVER
 Build: COLIBRI_499.9
 Watchdog: LYNX Server Watchdog - INTERN_jvo 6.1.0 (build 512, Aug 6 2012, 17:09:40)
 Serial number: 1

Logfiles

clear log history

Thu Aug 30 12:19:39 2012

© 2012 LYNX Technik AG | All rights reserved

Tip: The Web interface can also be accessed from the APPolo Control software. Select the IP address of the controller in the device tree and go to the Web Interface tab.

Remote Interfaces (for Option OH_RCT5023_Server)

SNMP Feature

The controller option supports a standard SNMPv2 control interface which allows read and write access to all parameters of the system as well as generating SNMPv2 Traps.

The MIB files (SNMP interface description) are available for download from <http://download.lynx-technik.de/public/embedded/SNMP/>

GET/SET

Full GET/SET/WALK access is provided to all all parameters of the associated signal processing modules as well as the infrastructure of the RCT 5023-G_Server (RCT 5023-G-S).

Regular SNMPv2 authentication is implemented. Due to this the community strings for read and write access are set to “public” resp. “private”. These default community strings can be adapted by modifying the hidden configuration variables SNMP_COMMUNITY_READ resp. SNMP_COMMUNITY_WRITE.

NOTE: *All configuration variables can be modified by specifying the config-keys (mentioned above) and the desired new values into the appropriate entry fields at the bottom of the “Configuration” Tab of the top-level node representing the RCT5023_Server (/RCT 5023-GS) in the LYNX APPolo Control software GUI.*

SNMP Traps

In addition to this get&set access (explained above), all Events that a processing module is able to generate can optionally be sent as SNMPv2 Traps. Refer to section “Events Tab” for more information on how an Event can be configured as an SNMP Trap.

In order to successfully send out SNMP Traps, the Trap receiver machine needs to be configured. You can specify one or more target-machines that shall receive all SNMP Traps from one RCT 5023-G_Server by editing the configuration variable SNMP_TRAP_TARGETHOST to one or more IP addresses (multiple IP addresses to be separated by the semicolon character ‘;’). Once this configuration has been made, the bluBox server process needs to be restarted. After that, all SNMP Traps from this one bluBox will be sent to all the specified IP addresses (port 162).

NOTE: *All configuration variables can be modified by specifying the config-keys (mentioned above) and the desired new values into the appropriate entry fields at the bottom of the “Configuration” Tab of the top-level node representing the RCT 5023-G_Server (/RCT 5023-G-S) in the LYNX APPolo Control software GUI.*

LYNX Remote Control Interface

The LYNX Remote Control Interface is a technical alternative to the SNMP Remote Control Interface mentioned in the previous section. The LYNX Remote Control Interface is available on port 2306 (TCP and UDP) and provides access to all readable and writeable parameters of the attached system.

There are certain advantages of the LYNX Remote Control Protocol over the SNMP Remote Protocol:

- It provides a very effective subscribe/callback mechanism. A remote controller does not have to send repeated read-commands (polling) in order to monitor an individual parameter
- It provides a dynamic query functionality which makes any kind of static interface description (like SNMP MIBs) obsolete. Instead the complete capabilities of the current system can be queried at runtime.
- It is very easy to develop / script / program because it is based on clear-text ASCII messages
- The LYNX Control system provides integrated debugging support which also makes it very simple to make yourself familiar with the simple scripting syntax

The technical documentation of the LYNX Remote Control Interface (one HTML page) is available free of charge from LYNX Technik. Please contact your local representative.

GPI Control

Through connections on the rack frame terminal panel GPI control for up to 9 GPIs (General Purpose Interface) is provided. This feature allows control of any parameter in an attached system with simple GPI contacts (contact closure against GND).

Note. Configuration of this function is possible through the APPolo GUI if a LYNX server (OH_RCT5023-SERVER) is installed in the attached system.

To start the application please click onto the Auto Control button in the command bar on top of the GUI window

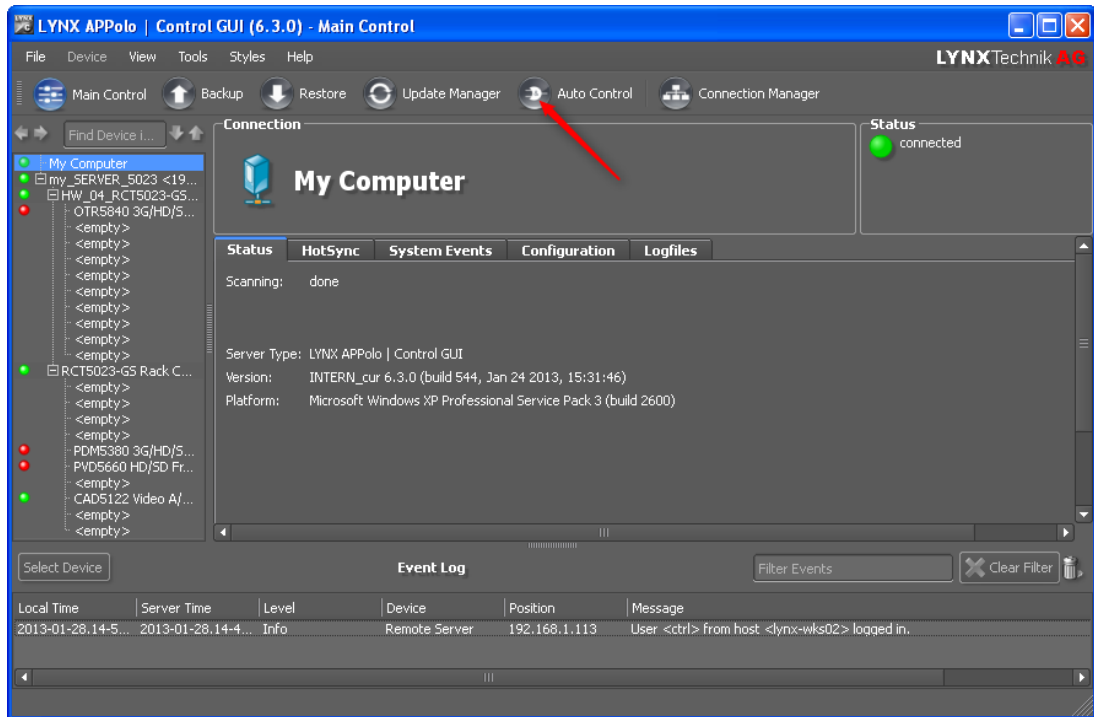

The following screen will be shown, where the different GPI actions can be configured. Up to 9 GPI contacts are available on one RCT 5023-G.

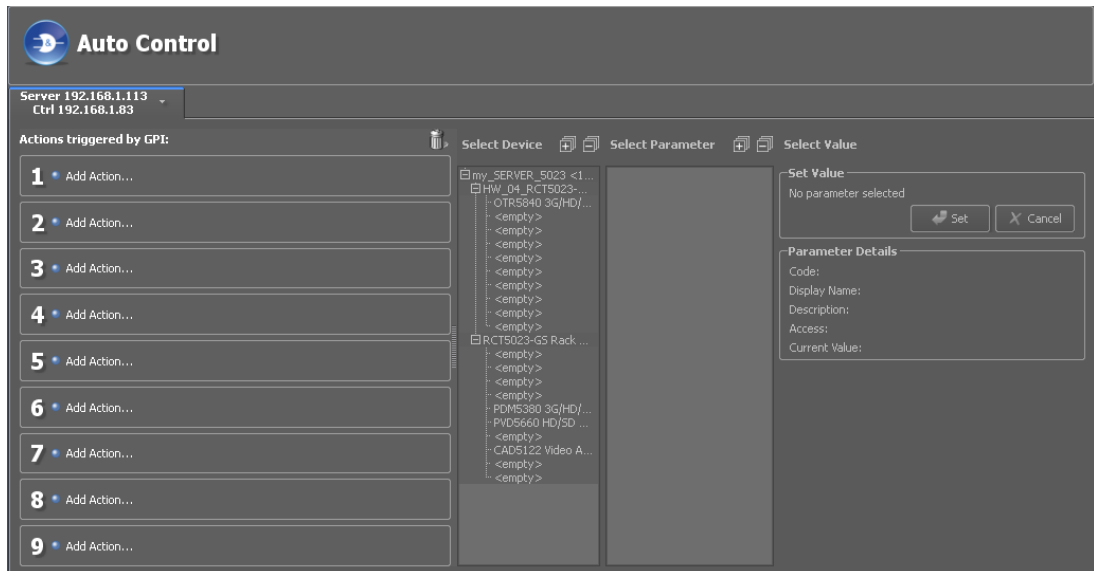

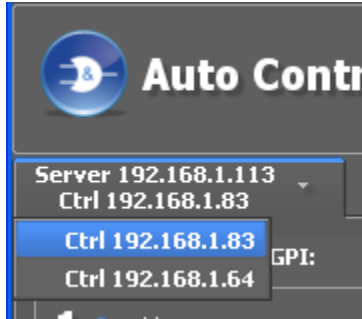

If a system contains multiple RCT 5023-G controllers you can select in between the different controllers for GPI configuration by selecting from the drop down list as shown on in the picture on the left.

If there are multiple servers connected, additional tabs will be shown.

The SW guides you through the necessary steps to configure actions for a specific GPI contact.

All actions are pulse triggered, i.e. a positive transition from 0 to 1 triggers that action.

To start configuration just click on “Add Action” and the next necessary step “Select Device” will be highlighted.

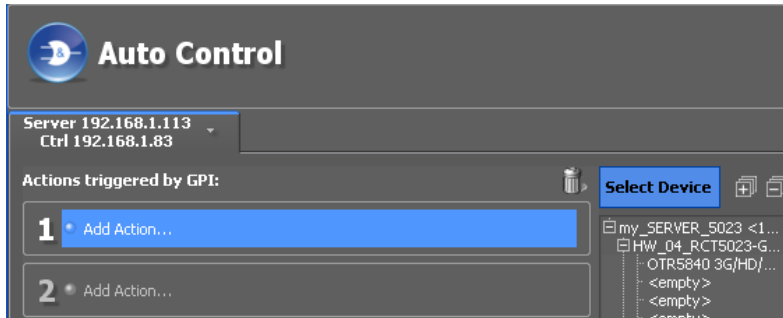

Select the device where you would like to control a single parameter through the GPI contact. All devices in the system are shown in the device tree.

The next step “Select Parameter” provides a list of all parameters of the selected device. Select the parameter, which should be controlled

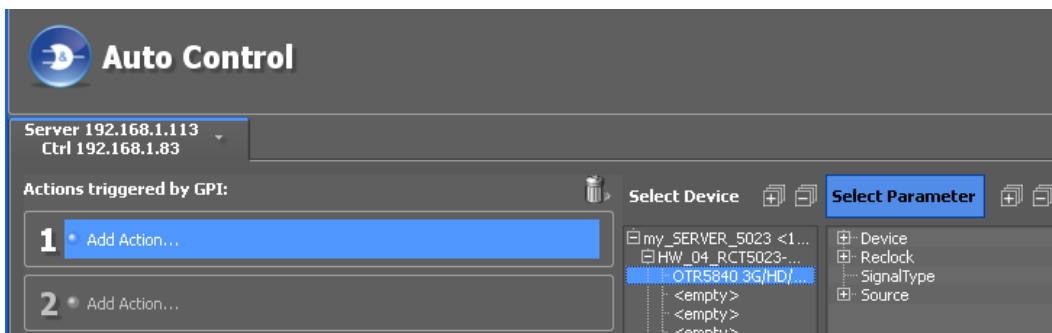

Finally select the value for the parameter in this action and click on “Set”

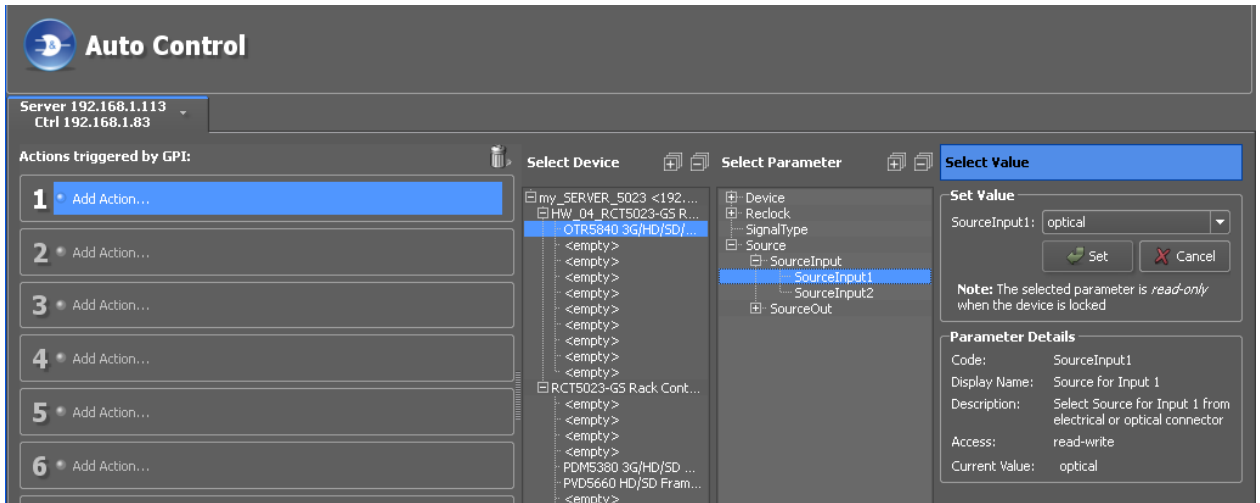

All defined actions are shown in the box for the associated GPI contact.

Note. Multiple actions can be set per GPI contact

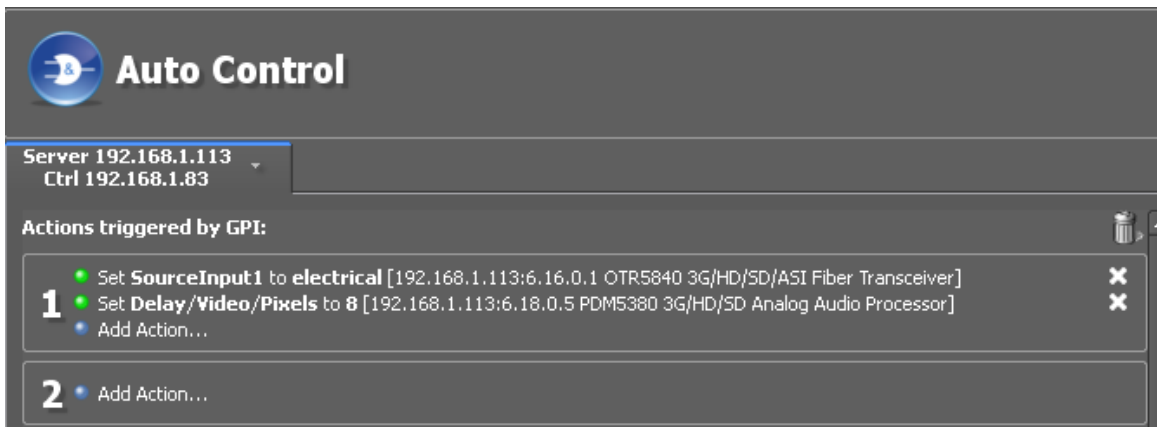

Note. If an action needs to be deleted either click on the cross sign behind the action or drag&drop the action into the basket on top of the list

Note. Changing the IP address of the RCT 5023-G will lead to a loss of the configured GPI actions, unless the RCT 5023-G is attached under the same stack address as before. This can be done manually during the attachment process

Note. Configured GPI actions will be stored in a back-up file of the associated server. The backup has to be executed on the IP node of this server.

Specifications

Electrical Specifications

Operating Voltage	+ 12VDC
Power Consumption	Approx 3 VA / 5 VA with OH_RCT5023_Server Option
Safety	IEC 60950/ EN 60950/VDE 0805

Mechanical

Size	283mm x 78mm
Weight	Card module 120g /150g with Server Option

Ambient

Temperature	5°C to 40°C Maintaining specifications
Humidity	Max 90% non-condensing

Supplied Accessories

Documentation	Reference Manual CD
---------------	---------------------

Service

Parts List

Due to the very dense design and high level of integration there the module is not user serviceable. Please contact LYNX for repairs or to request an exchange unit.

Technical Support

If you are experiencing problems, or have questions please contact your local distributor for further assistance.

Technical support is also available from our website.

Please do not return products to LYNX without an RMA. Please contact your authorized dealer or reseller for more details.

More detailed product information and product updates may be available on our web site:

www.lynx-technik.com

Contact Information

Please contact your local distributor; this is your local and fastest method for obtaining support and sales information.

LYNX Technik can be contacted directly using the information below.

Address LYNX Technik AG
 Brunnenweg 3
 D-64331 Weiterstadt
 Germany

Website www.lynx-technik.com

E-Mail info@lynx-technik.com

LYNX Technik manufactures a complete range of high quality modular products for broadcast and Professional markets, please contact your local representative or visit our web site for more product information.

LYNXTechnik AG[®]
Broadcast Television Equipment