

Marshall

Broadcast A/V Division

CV420e

Compact **UHD60fps ePTZ** Camera
(USB, IP & HDMI)



User Manual

Table of Contents

- Chapter 1** Package Contents2
- Chapter 2** Function Introduction.....3
 - 2.1** I/O functions Introduction3
 - 2.2** Tally Lamp Function Description.....3
- Chapter 3** Instruction for installation.....4
 - 3.1** Basic Devices4
- Chapter 4** System diagram.....5
- Chapter 5** Remote Control and Setting Menu6
 - 5.1** Functions of remote control.....6
 - 5.2** Setting Menu.....7
- Chapter 6** Network Function Settings Description13
 - 6.1** Web System Requirements13
 - 6.2** Web Page Function Description14
- Chapter 7** Troubleshooting27
- Chapter 8** Safety Instructions28
- Warranty Information**29

CHAPTER 1: PACKAGE CONTENTS



CHAPTER 2: FUNCTION INTRODUCTION

2.1 I/O Functions Introduction

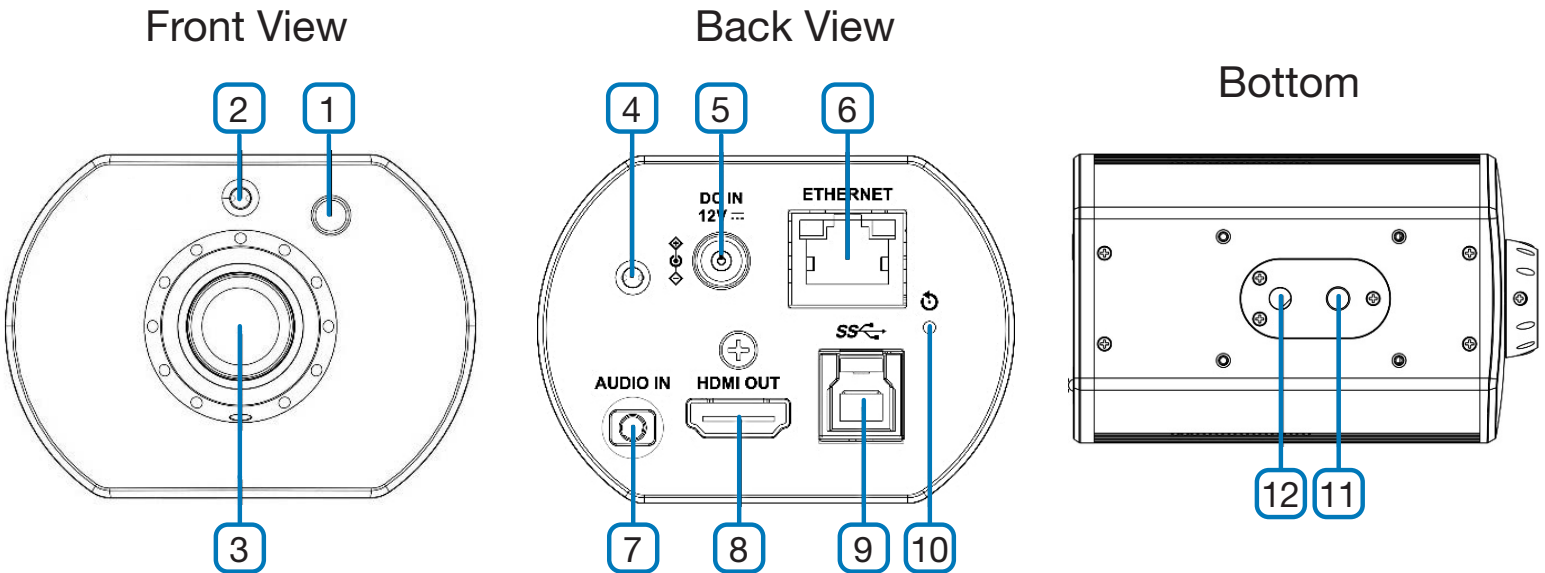

#	Item	Function Descriptions
1	IR receive	Support infrared remote control
2	Tally Lamp	Display the Tally Lamp status of the camera
3	Lens	HD camera lens
4	Power indicator	Display the status of the camera
5	DC 12 V power connector	AC power supply connecting port
6	Network port	Network cable port supports routers or hubs of IEEE802.3af with PoE power supply
7	Audio input	Support Line In/Mic In audio input
8	HDMI 2.0 output	Connect to HDMI output signal source
9	USB 3.0 Type-B port	Connect to the computer using a USB cable; capture images via the software
10	Reset button	Press and hold for 5 seconds to reset the machine
11	Tripod locating holes	Tripod locating holes
12	Tripod screw holes	Support 1/4", 20 UNC

2.2 Tally Lamp Function Description

2.2.1 The tally indicator light function may be enabled through the control of VISCA command. The setting method is as follows:

Tally Mode: 8x 01 7E 01 0A 01 0p FF
 p = 4: **On** (half-brightness)
 p = 5: **On** (full-brightness)

CHAPTER 3: INSTRUCTIONS FOR INSTALLATION

3.1 Basic Devices

3.1.1 CV420e size
 Length x Width x Height: 122.06 x 70 x 51 mm Weight: 0.35 Kg

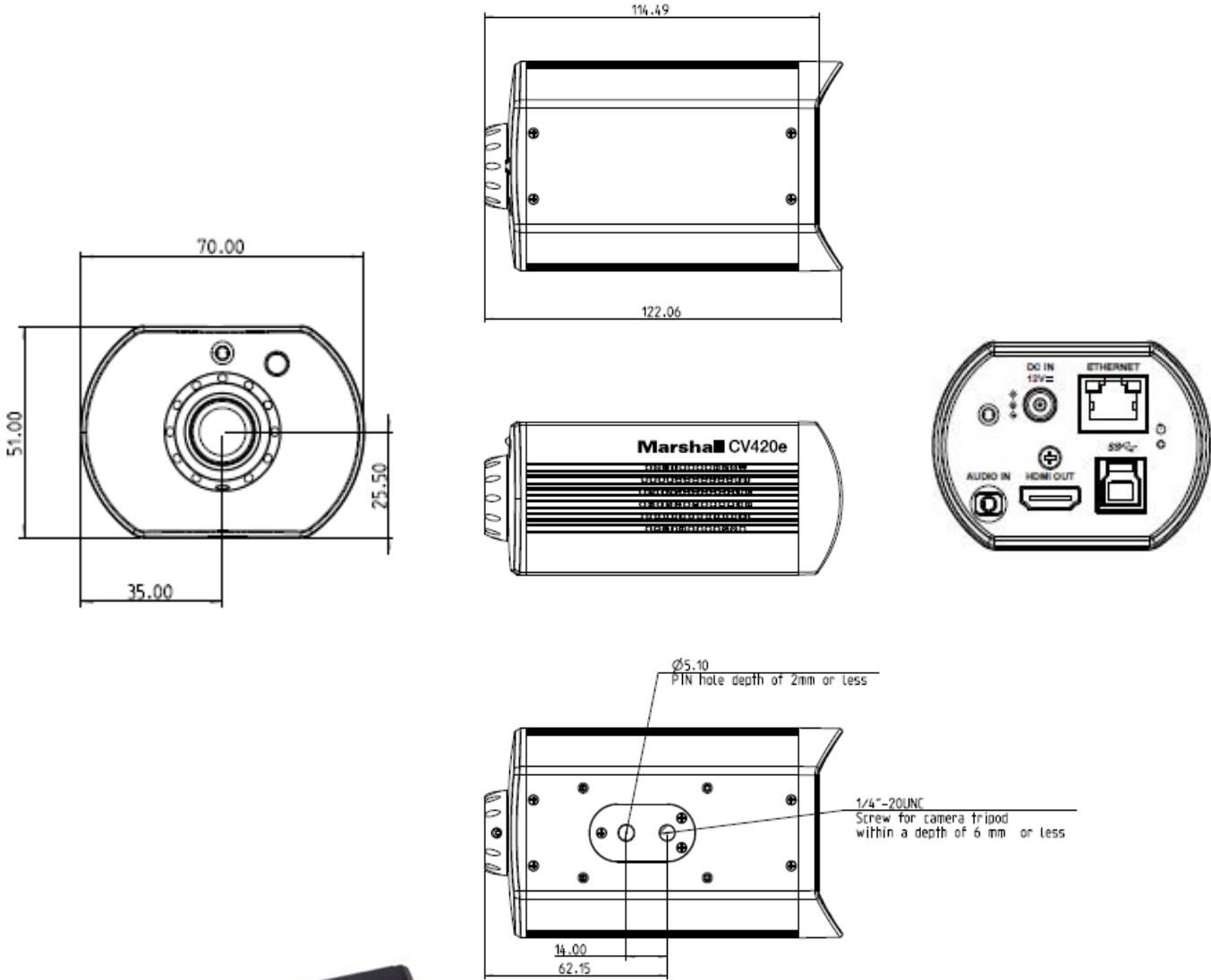

3.1.2 Installation Method

You can use the included Marshall CVM-5 monitor and desk stand, or any 1/4"-20 capable camera mount type to attach to tripods, wall mounts, ceiling mounts, etc

CHAPTER 4: SYSTEM DIAGRAM

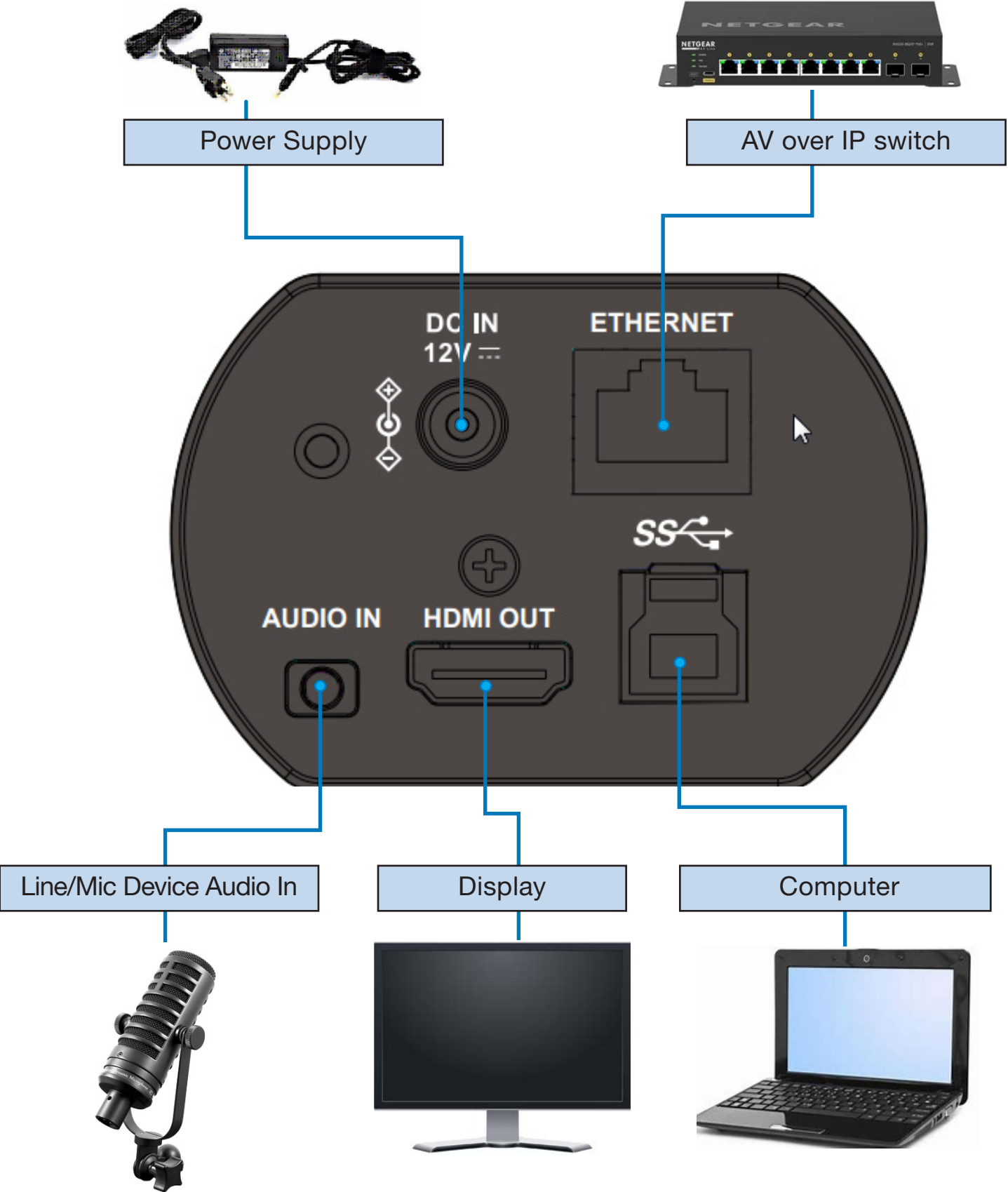

CHAPTER 5: REMOTE CONTROL & SETTING MENU

5.1 Functions of Remote Control*

*IR remote included in this package

Item	Description
◀ ▶ ▲ ▼	Move the lens
Back Light	Turn on/off back light compensation
Camera select	Choose Camera ID 1~3
Focus- Manual /Far/Near	Reserved
Focus-Auto	Reserved
Freeze	Freeze the screen
Home-Enter	Go back to the main page / Execute
Info	Status information
L/R Direction Set	L/R Direction / Normal
Menu	Display OSD menu
Mirror	Rotate the image (OFF / Mirror / Flip / Rotate)
Pan/Tilt Reset	Clear the Pan / Tilt setting
Picture	Switch image effect (OFF / Neg / B&W)
Power	Power Switch
Preset	Appoint an ID (0~9) to save the current position data
Reset	Appoint an ID (0~9) to delete the current position data
Zoom-Fast	Adjust image size
Zoom-Slow	Fine-tune image size



5.2 Setting Menu

Press [Menu] on the remote control to enter the setting menu; the **bold underlined** values in the following table are defaults.

1 st Level Major Items	2 nd Level Minor Items	3 rd Level Adjustment Values	Function Descriptions	
Exposure	Mode	1. <u>Full Auto</u> 2. Shutter Pri 3. Manual	Exposure mode setting	
	Exposure Comp.	On/ <u>Off</u>	AE Level	
	Exposure Comp. Level	-5~ <u>C</u> ~5	The value can be adjusted after Exposure Comp. is activated	
	Spot Light	On/ <u>Off</u>		
	Spot Light Position	X(0~6)Y(0~4)	The value can be adjusted after Spot Light is activated	
	Shutter Pri		60/30 mode 50/25 mode	Adjustable when the Exposure mode is set to Shutter Pri
			1/10000 1/10000	
			1/5000 1/5000	
			1/3000 1/3000	
			1/2500 1/2500	
			1/2000 1/1750	
			1/1500 1/1250	
			1/1000 1/1000	
			1/725 1/600	
			1/500 1/425	
			1/350 1/300	
			1/250 1/215	
			1/180 1/150	
			1/120 1/120	
			1/100 1/100	
1/90 1/75				
<u>1/60</u> <u>1/50</u>				
1/30 1/25				
1/15 1/12				
1/8 1/6				
1/4 1/3				
1/2 1/2				
1/1 1/1				

1 st Level Major Items	2 nd Level Minor Items	3 rd Level Adjustment Values	Function Descriptions
	Manual Gain	<u>0dB</u> / 3 dB/ 6 dB/ 9 dB/ 12 dB/ 15 dB/ 18 dB/ 21 dB/ 24 dB/ 27 dB/ 30 dB/ 33 dB/ 36 dB/ 39 dB/ 42 dB/ 45 dB	Adjustable when the Exposure mode is set to Manual
		60/30 mode 50/25 mode	Manually set the shutter
		1/10000 1/10000	
		1/5000 1/5000	
		1/3000 1/3000	
		1/2500 1/2500	
		1/2000 1/1750	
		1/1500 1/1250	
		1/1000 1/1000	
		1/725 1/600	
1/500 1/425			
Manual Speed		1/350 1/300	Manually set the shutter
		1/250 1/215	
		1/180 1/150	
		1/120 1/120	
		1/100 1/100	
		1/90 1/75	
		1/60 1/50	
		1/30 1/25	
		1/15 1/12	
		1/8 1/6	
Gain Limit		9 dB/ 12 dB/ 15 dB/ 18 dB/ 21 dB/ 24 dB/ 27 dB/ 30 dB/ 33 dB/ 36 dB/ 39 dB/ 42 dB/ <u>45 dB</u>	Max. limit value of electron gain
		1/1 1/1	
WDR		1. <u>Disable</u>	
		2. 1	
		3. 2	
		4. 3	

1 st Level Major Items	2 nd Level Minor Items	3 rd Level Adjustment Values	Function Descriptions
White Balance	Mode	<ol style="list-style-type: none"> Auto Indoor Outdoor One Push WB ATW Manual Sodium Lamp 	Select the color temperature mode <ol style="list-style-type: none"> 4000k ~ 7000k 3200k 5800k 1700k ~ 10000k 1700k ~ 10000k Custom 2800k
	One Push Trigger	ENTER	One push trigger
	Manual Red	0~ C ~128	Adjustable when the white balance mode is set to Manual
	Manual Blue	0~ C ~128	Adjustable when the white balance mode is set to Manual
Picture	Picture effect	<ol style="list-style-type: none"> Disable Neg B & W 	
	Sharpness	0~ A ~14	
	2D NR	<ol style="list-style-type: none"> Disable 1 2 3 	
	3D NR	<ol style="list-style-type: none"> Disable Low Typ Max 	
	Image Mode	<ol style="list-style-type: none"> Default Custom 	The user may customize his/her desired image mode
	Image Mode Load	ENTER	Adjustable when the Image mode is set to Custom . After selected, the corresponding Image mode parameters will be read and applied to Custom
	Brightness	0~ A ~15	Adjustable when the Image mode is set to Custom
	Hue	0~ A ~15	Adjustable when the Image mode is set to Custom
	Saturation	0~ A ~15	Adjustable when the Image mode is set to Custom
	Gamma	0~ A ~3	Adjustable when the Image mode is set to Custom
Pan Tilt Zoom	Pan Flip	On/ Off	Activate the reverse Pan direction
	Tilt Flip	On/ Off	Activate the reverse Tilt direction

1 st Level Major Items	2 nd Level Minor Items	3 rd Level Adjustment Values	Function Descriptions
	Zoom Mode	Clear Image Zoom/Digital Zoom	
D-Effect	Mirror	<ol style="list-style-type: none"> Disable Mirror Flip Mirror + Flip 	Set the mode at which the image is mirror or flipped
Ethernet	DHCP	On/Off	Enable/Disable DHCP setting using left and right arrow keys and press [ENTER] to apply setting.
	IP Address	192.168.100.100	Press [ENTER] to be in modify mode; select the item to be modified using the up and down keys, and modify the value using the left and right keys or the numeric keys.
	Subnet Mask	255.255.255.0	Press [ENTER] to be in modify mode; select the item to be modified using the up and down keys, and modify the value using the left and right keys or the numeric keys.
	Gateway	192.168.100.254	Press [ENTER] to be in modify mode; select the item to be modified using the up and down keys, and modify the value using the left and right keys or the numeric keys.
Audio	Audio In	Line In/Mic In	Set Audio In
	Audio Enable	On/ Off	Turn on/off audio output
	Audio Volume	0~ A ~10	Audio Volume Setting
	Audio Delay	On/ Off	When the audio is not synchronized with the video, enable this function to set the audio delay time
	Audio Delay Time (ms)	-1~-500ms	Set audio delay time
	Encode Type	<ol style="list-style-type: none"> AAC G.711 	Set audio encode type

1 st Level Major Items	2 nd Level Minor Items	3 rd Level Adjustment Values	Function Descriptions
	Encode Sample Rate	<ol style="list-style-type: none"> 48 KHz(AAC) 44.1 KHz(AAC) 16 KHz(AAC) 16 KHz(G.711) 8 KHz(G.711) 	Set the encode type and sample rate
System	Prompt	On/ Off	Turn on/off the prompt information on the display
	IR Receive	On/Off	When it is Off, the remote control will not be able to control the camera. At this moment, turn off and then turn on the power to restore control of the remote control.
	Tally Lamp	On/Off	Enable/ disable Tally Lamp function.
	Tally CMMD Mode	Normal/Link	Set if the Tally lamp is linked with RS232 command <ul style="list-style-type: none"> Normal (non-linked): The tally lamp and the mode need to be set separately. - Tally lamp On: default mode is no light, need to send command to set the lamp mode - Tally lamp Off: when set the mode, it will not be triggered to enable the tally lamp function.. Link: <ul style="list-style-type: none"> - Tally lamp On: the default lamp mode is red light. - Tally lamp Off: when set the mode, it will trigger to enable the tally lamp function.
	Language	English/Chinese	
	Initial Position	Last MEM/ 1st Preset	Select the camera lens to return to the last operated position or the first preset position after POWER ON

1 st Level Major Items	2 nd Level Minor Items	3 rd Level Adjustment Values	Function Descriptions		
	Output Mode	<ol style="list-style-type: none"> 3840x2160/60p 3840x2160/59.94p 3840x2160/50p 3840x2160/30p 3840x2160/29.97p 3840x2160/25p 1080p/60 1080p/59.94 1080p/50 1080p/30 1080p/29.97 1080p/25 720p/60 720p/59.94 720p/50 720p/30 720p/29.97 720p/25 1080i/60 1080i/59.94 1080i/50 	Choose the output resolution		
		Output Source		HDMI+Streaming (IP) HDMI+UVC (USB)	
		Factory Reset		On/ Off	Resume the factory default setting
Status					Display the current setting status

CHAPTER 6: NETWORK FUNCTION SETTING DESCRIPTION

6.1 Web System Requirements

Operating System	Version	Browser
Windows	7 (64 bits) and above	FireFox
		Chrome
	10 (64 bits) and above	Edge
		FireFox
Mac	10.14 and above	Chrome
		Safari
		FireFox

6.2 Connecting Camera to Network

Two common connection methods are shown below

1. Connecting via switch or router

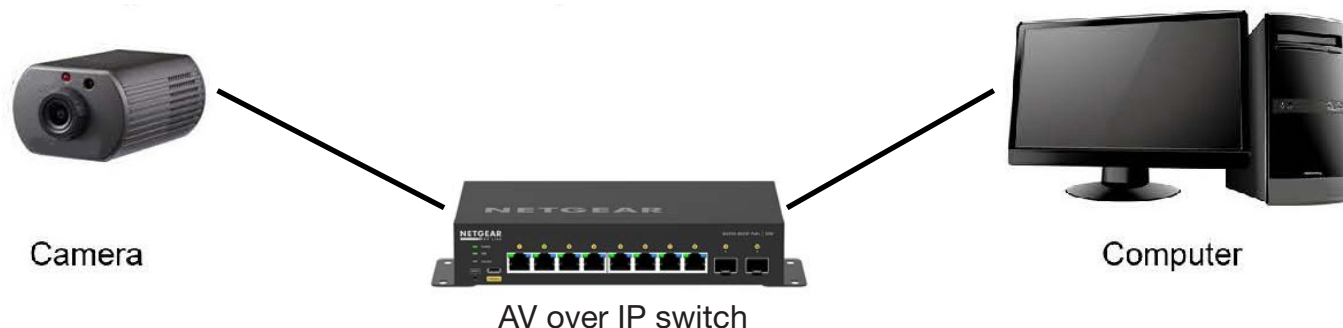

2. To connect directly through network cable, the IP address of the computer should be changed so that it is on the same network segment as the camera

E.g.: The factory-preset default IP address of the camera is 192.168.100.100.

The computer IP address must be set with the same network segment, such as 192.168.100.101, so that the computer can be connected correctly with the camera

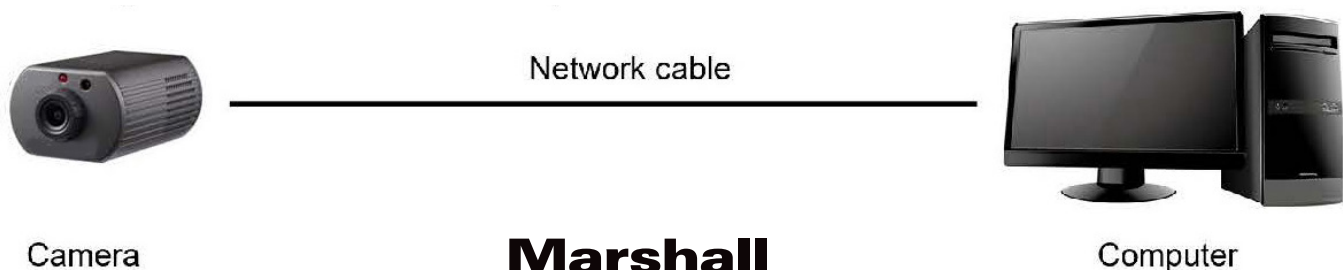

• Change network settings

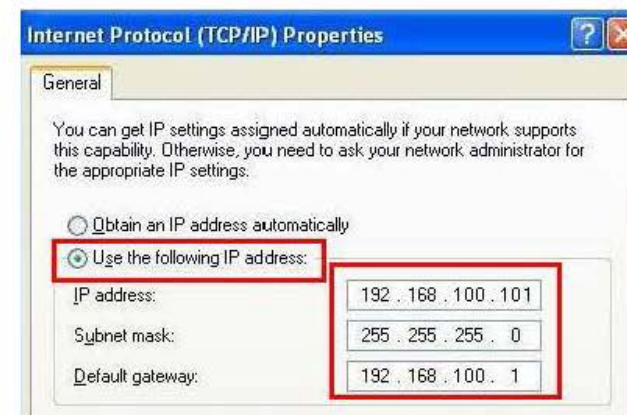

6.2.2 Using the Browser to View the Images

- Open the browser, and enter the IP address of the camera in the address bar
E.g.: <http://192.168.100.100> (default IP address)
- Enter administrator's account and password

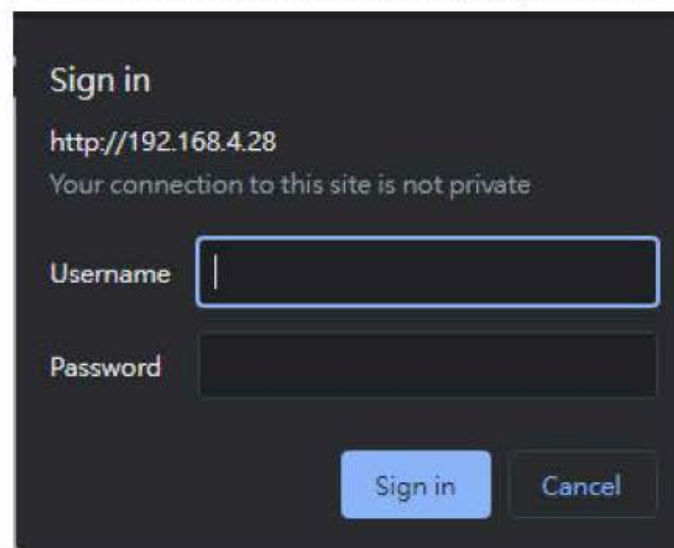

Network Camera

- Account: admin
- Password: 9999 (Default)

6.2.3 Using RTSP Player to View the Images

Free software can be used for RTSP connection, such as VLC, Quick Time and PotPlayer

RTSP connection address formats are as follows:

- RTSP Sub1 Streaming => <rtsp://camera IP:8557/h264>
- RTSP Sub2 Streaming => <rtsp://camera IP:8556/h264>

If password authentication is enabled, the RTSP connection address is as follows:

- <rtsp://Username:Password@VC IP address:port/h264>

Example:

Open the VLC software, click [Open Network Streaming], and enter the URL:

<rtsp://192.168.100.100:8557/h264>

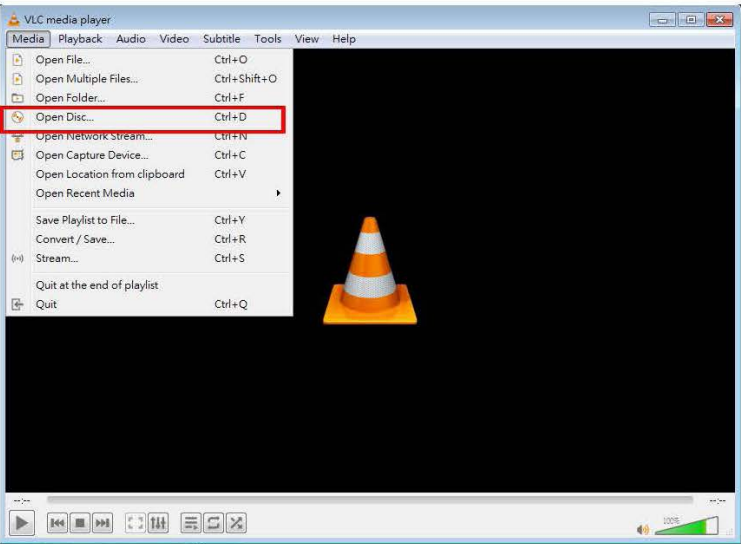

6.3 Web Page Menu Function Description

6.3.1 Login Screen

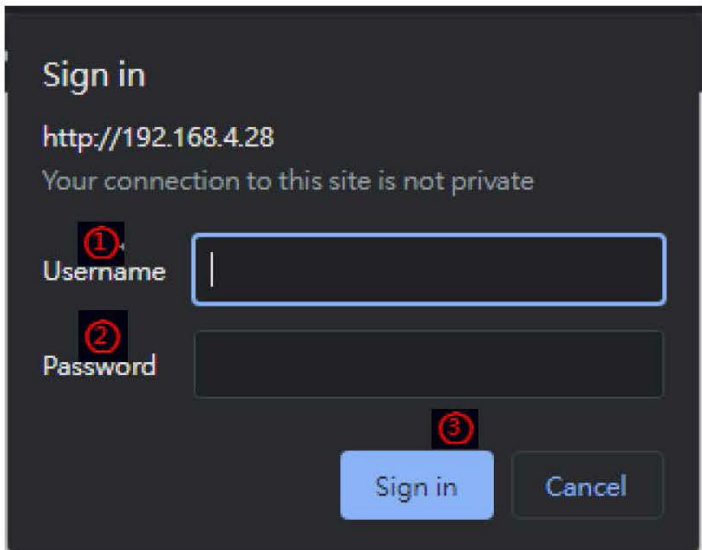

No	Item	Function Descriptions
1	Username	Enter user login account (default: admin)
2	Password	Enter user password (default: 9999)
3	Sign in	Sign in the administrator screen on the website

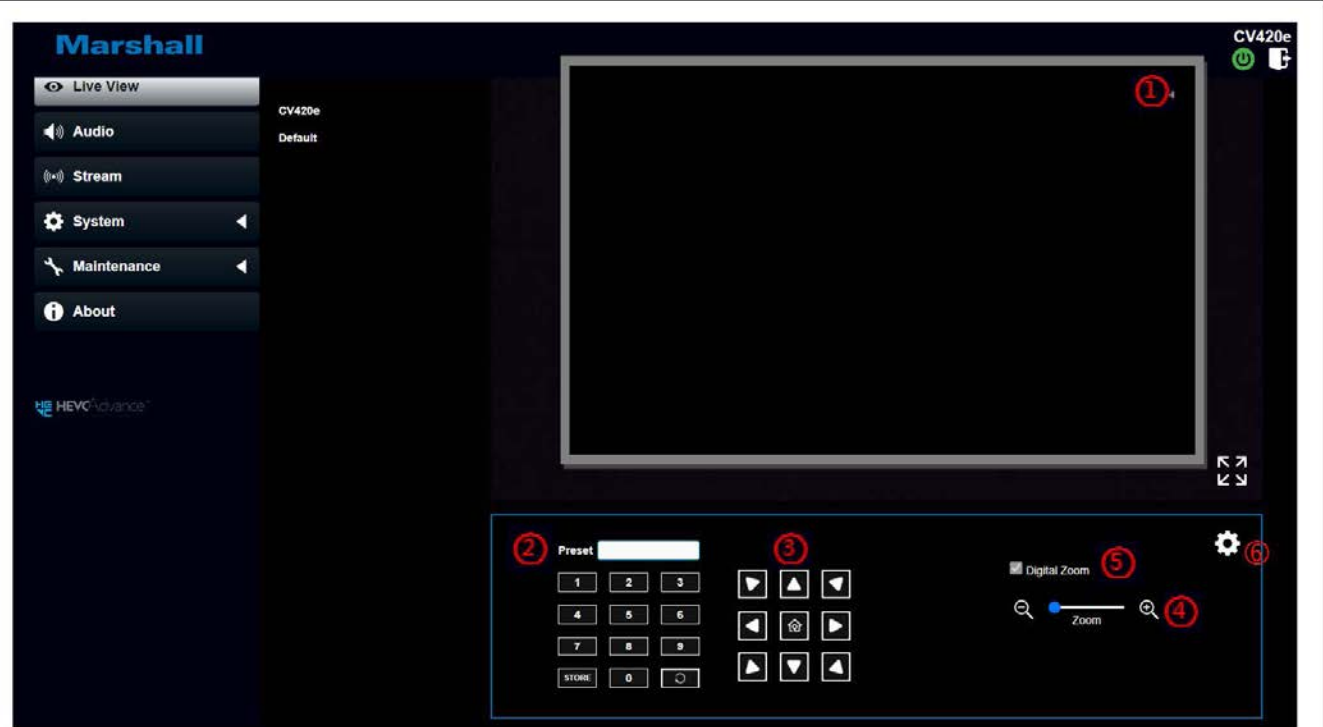

6.3.2 Live Video – PTZ Control



No	Item	Function Descriptions
1	Preview window	Display the screen currently captured by the camera
2	Preset setting	Select the number first and then select SAVE or LOAD
3	Pan / Tilt setting	Adjust the Pan/Tilt position of the camera screen
4	Zoom	Zoom In/Zoom Out ratio
5	Digital Zoom	Enable/ disable digital zoom
6	Camera Setting	Switch to camera setting page

6.3.3 Live Video – Camera



No	Item	Function Descriptions
1	Preview window	Display the screen currently captured by the camera
2	Exposure	<ul style="list-style-type: none"> Mode: Select exposure mode (Full Auto/Shutter Pri/Iris Pri/Manual/ White Board) Gain Limit: Adjust the gain limit (adjustable only under the "Manual") Exposure Comp. Level: Select exposure compensation level WDR: Set the level of wide dynamic range (WDR) in order to obtain better images Shutter Speed: Adjust the shutter speed (adjustable only under the "Manual" or "Shutter Priority")
3	White Balance	 <ul style="list-style-type: none"> Mode: Select the color temperature mode Open Push WB: Single color temperature execution adjustment (adjustable only under the "One Push WB") Manual Red/Blue: Manually adjust blue/red color temperature
4	Mirror	 <ul style="list-style-type: none"> Mirror: Set the automatic flip mode (OFF / Mirror / Flip / Mirror + Flip)
5	Picture	 <ul style="list-style-type: none"> Picture effect :Set picture effect, Off/Neg/Black and White 2D NR: 2D noise reduction settings 3D NR: 3D noise reduction settings Image mode: The user may customize his/her desired image mode Image mode Load: Default Mode Gamma: Gamma Level adjustment; Adjustable when the image mode is set to Custom Brightness: Brightness adjustment of the image; Adjustable when the image mode is set to Custom Saturation: Saturation adjustment of the image; Adjustable when the image mode is set to Custom Sharpness: Sharpness adjustment of the image Hue: Adjustable when the Image mode is set to Custom

6.3.4 Audio

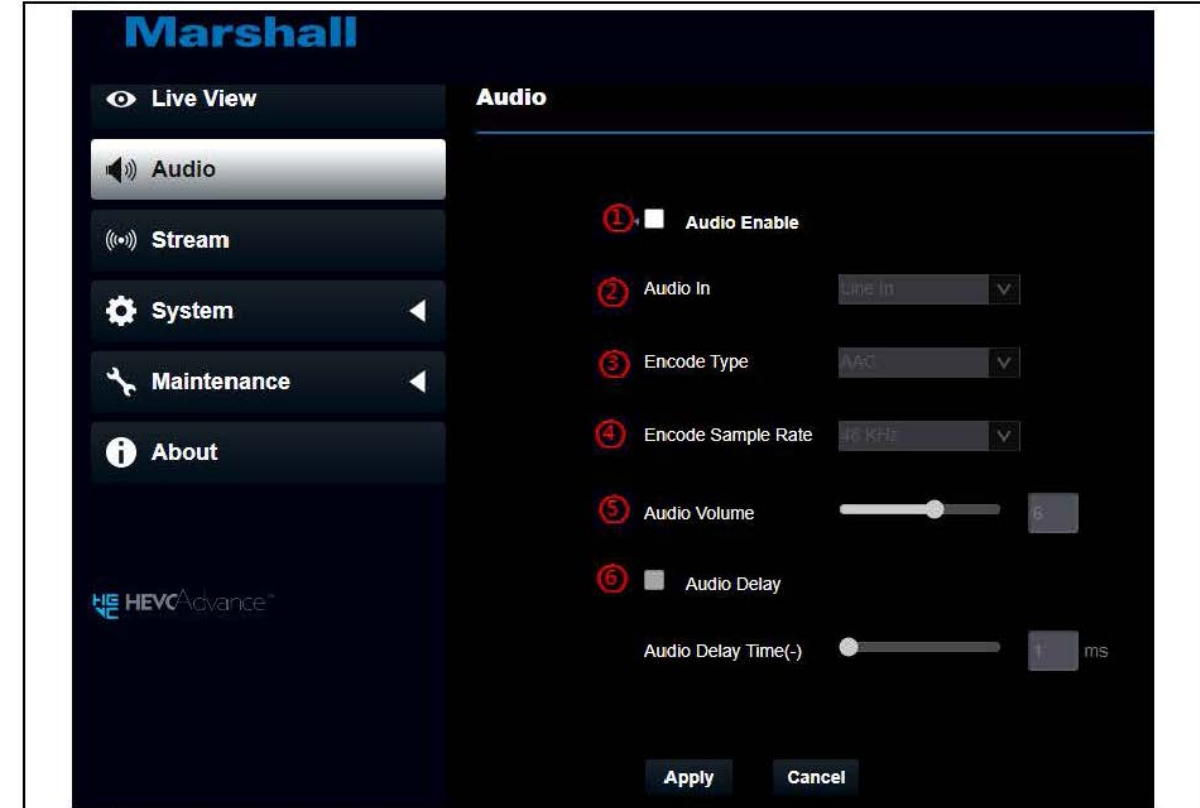

No	Item	Function Descriptions
1	Audio Enable	Turn on/off sound
2	Audio In	Set MIC In/Line In
3	Encode Type	AAC / G.711
4	Encode sample rate	Set encode sample rate <ul style="list-style-type: none"> 48 KHz (AAC) 44.1 KHz (AAC) 16 KHz (AAC) 16 KHz(G.711) 8 KHz(G.711)
5	Audio Volume	Adjust Audio Volume
6	Audio Delay	After checking the box, set the audio delay time (1 ~ -500 ms)

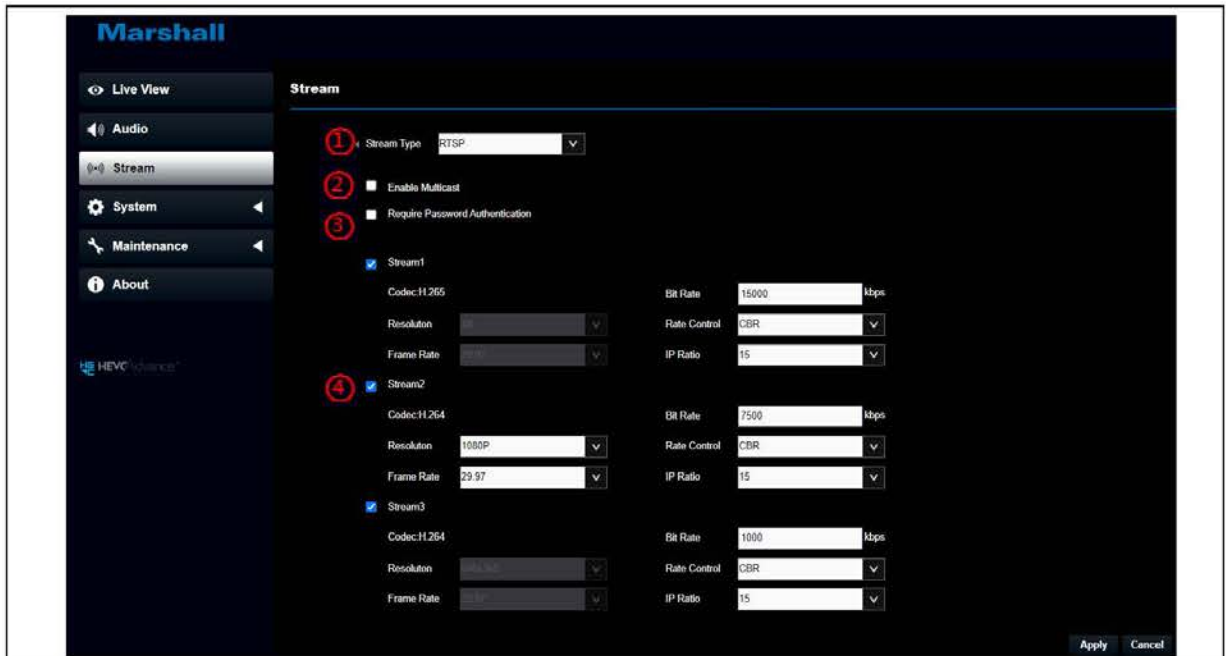

No	Item	Function Descriptions
1	Streaming types	Supporting RTSP/RTMP/RTMPS/MPEG-TS/SRT
2	Enable Multicast	Enable/Disable Multicast It is suggested to enable Multicast when the number of users online watching the live image simultaneously is more than 4
3	Authentication	Enable/Disable Password Authentication <ul style="list-style-type: none"> RTSP connection format can be found in 6.2.3 Using RTSP Player to View the Images The username/password is the same as the web login password of the camera
4	Streaming 1 Streaming 2 Streaming 3	Supporting 3-way streaming output

Streaming parameter setting

Function	Streaming 1	Streaming 2	Streaming 3
Encode Format	H.265	H.264	
Resolution	4K	1080P / 720P / 1080i/ 640x360	640x360
Frame Rate	Setting according to the supported resolution <Remark> Only 59.94 / 50 are supported when the resolution of Streaming 2 is 1080i		
Bit Rate(kbps)	Range	2,000~20,000	512~5,000
	Factory Default	15,000	1,000
Rate Control	CBR / VBR		
IP Ratio	Setting according to the supported resolution		

6.3.6 Setting - Device Setting

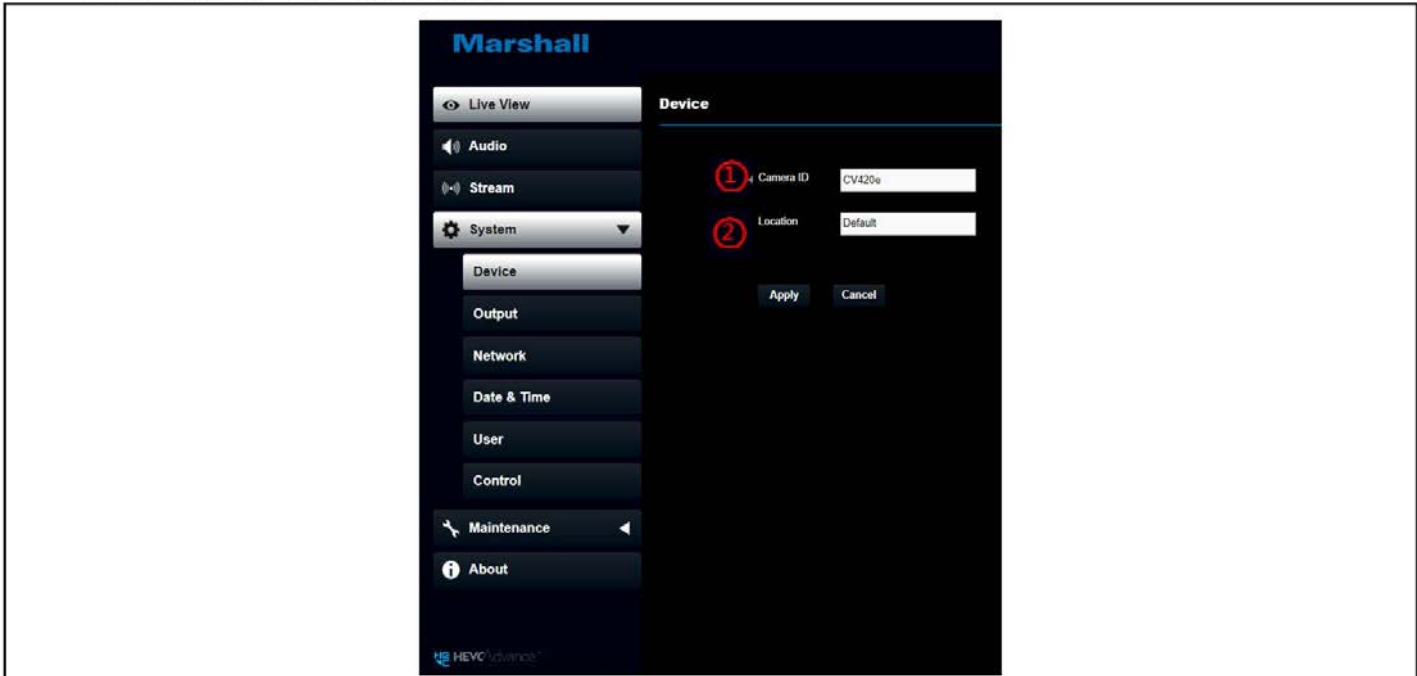

No	Item	Function Descriptions
1	Camera name	Change camera name here <ul style="list-style-type: none"> Supporting 1 - 12 characters for the camera name Please mix uppercase and lowercase letters or numbers for characters. Special symbols such as "/" and "space" cannot be used
2	Camera Location	Modify the location of the camera, such as Room 1 <ul style="list-style-type: none"> Supporting 1 - 11 characters for the camera location Please mix uppercase and lowercase letters or numbers for characters. Special symbols such as "/" and "space" cannot be used



No	Item	Function Descriptions
1	Resolution	Set the resolution of the camera After switching the resolution, the camera will restart. Please refresh the browser
2	Output Source	According to the output resolution, you can select HDMI + streaming output or HDMI + UVC output
3	HDMI format	Select YUV422/ YUV420 /RGB <Remark> When it is set to YUV420, 3840 x 2160 59.94p and 3840 x 2160 50p resolutions are supported
4	UVC	This can be seen when System - Output is set to HDMI + UVC <ul style="list-style-type: none"> ■ Encode Format: <ul style="list-style-type: none"> ➢3840x2160 / 29.97 / 25 : H.264 ➢Less than 1080p (inclusive): H.264/MJPEG ■ Resolution: It is shown based on Resolution Frame Rate: 3840x2160 can only select the highest 29.97
5	Overlay	User can select to display the "Date/Time" or "Text" when streaming

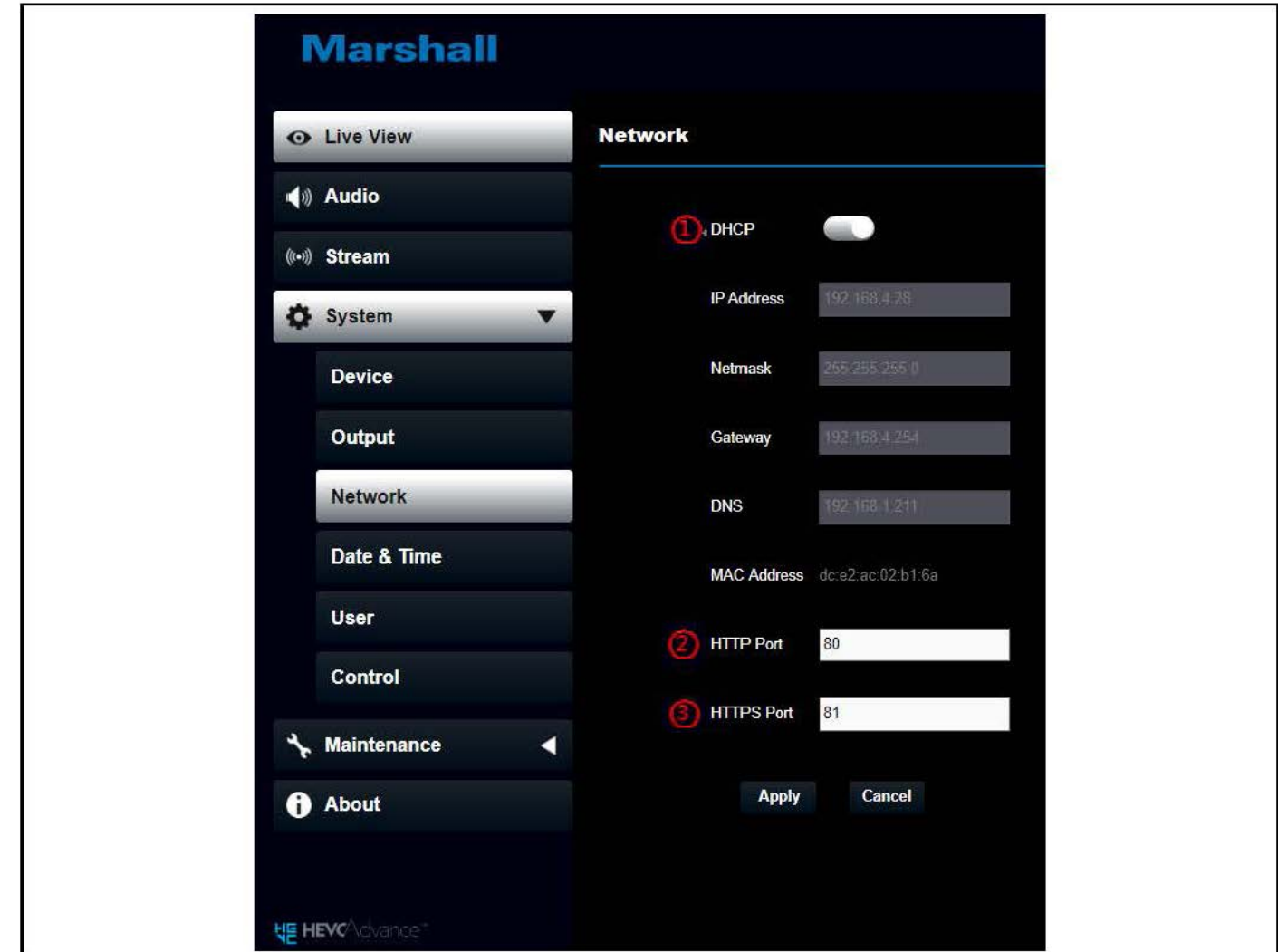

No	Item	Function Descriptions
1	DHCP	Network setting of camera. Change of setting is available when DHCP function is closed
2	HTTP port	Set HTTP port. The default Port value is 80 × Change of setting is available only when DHCP function of camera is closed
3	HTTPS port	Set HTTPS port. The default Port value is 81 × Change of setting is available only when DHCP function of camera is closed

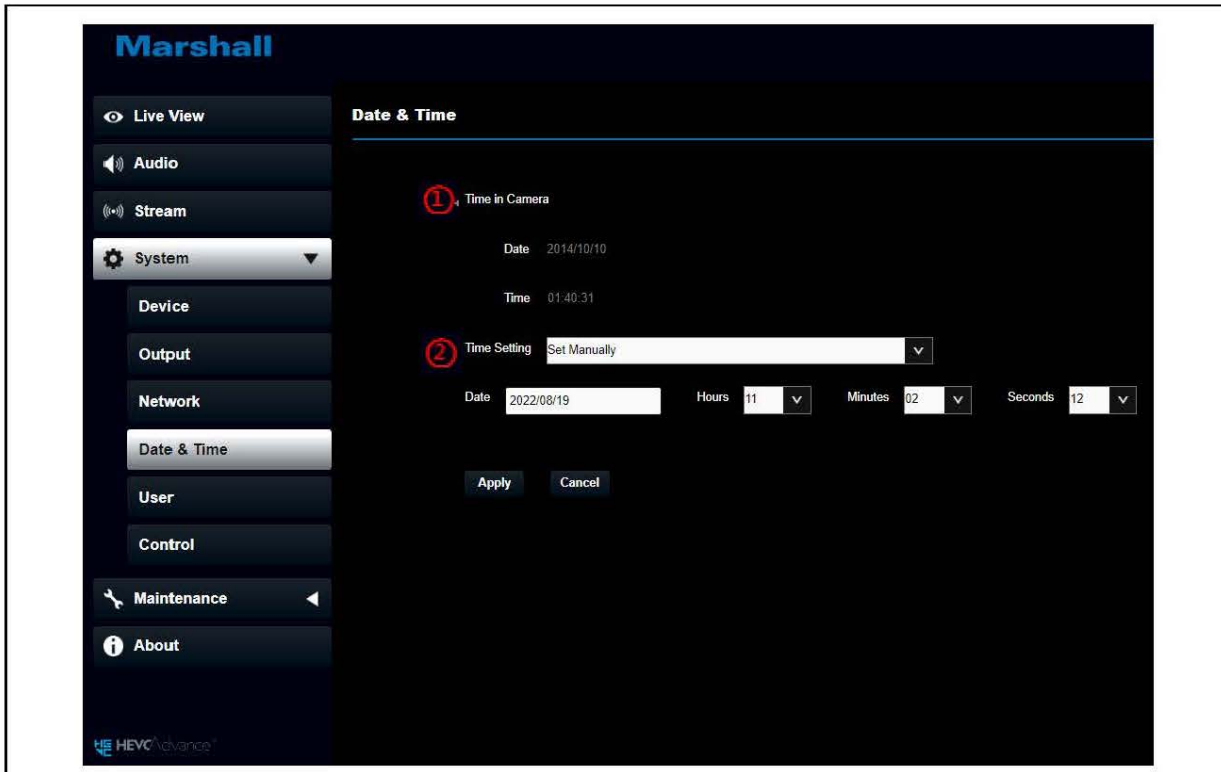

No	Item	Function Descriptions
1	Time in Camera	Display the date and time of the camera
2	Time Setting	<ul style="list-style-type: none"> Manual Configuration: Set time manually Synchronize with computer time: Set the camera time according to the computer time Synchronize with SNTP server: Set the camera time synchronously with the SNTP server

6.3.10 Setting - User

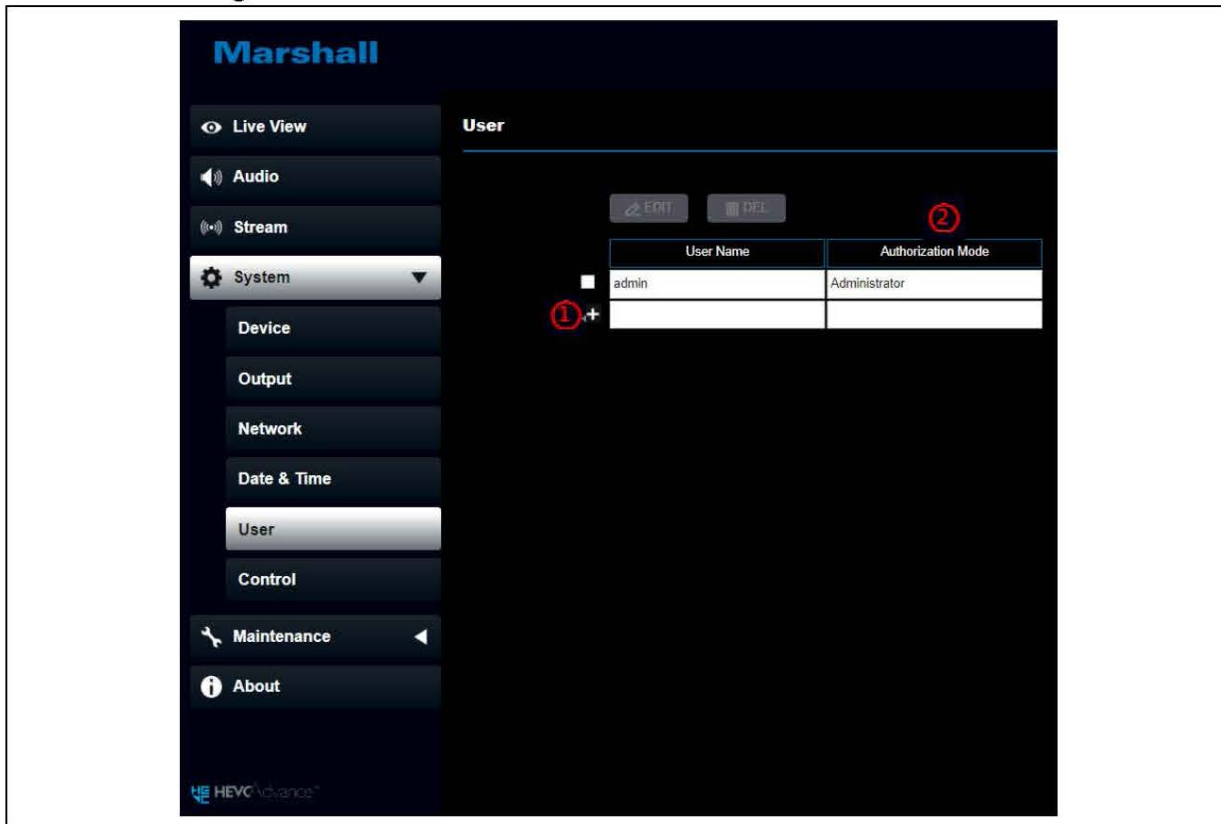

No	Item	Function Descriptions																
1	Add user account	Enter a user name and password to add a new user																
2	Authentication Mode	Set the new account management permissions <table border="1"> <thead> <tr> <th>User Type</th> <th>Administrator (Admin)</th> <th>Operator (Operator)</th> <th>Viewer (Viewer)</th> </tr> </thead> <tbody> <tr> <td>View images</td> <td>V</td> <td>V</td> <td>V</td> </tr> <tr> <td>Settings</td> <td>V</td> <td>V</td> <td>X</td> </tr> <tr> <td>Account management</td> <td>V</td> <td>X</td> <td>X</td> </tr> </tbody> </table>	User Type	Administrator (Admin)	Operator (Operator)	Viewer (Viewer)	View images	V	V	V	Settings	V	V	X	Account management	V	X	X
User Type	Administrator (Admin)	Operator (Operator)	Viewer (Viewer)															
View images	V	V	V															
Settings	V	V	X															
Account management	V	X	X															

6.3.11 System - Control

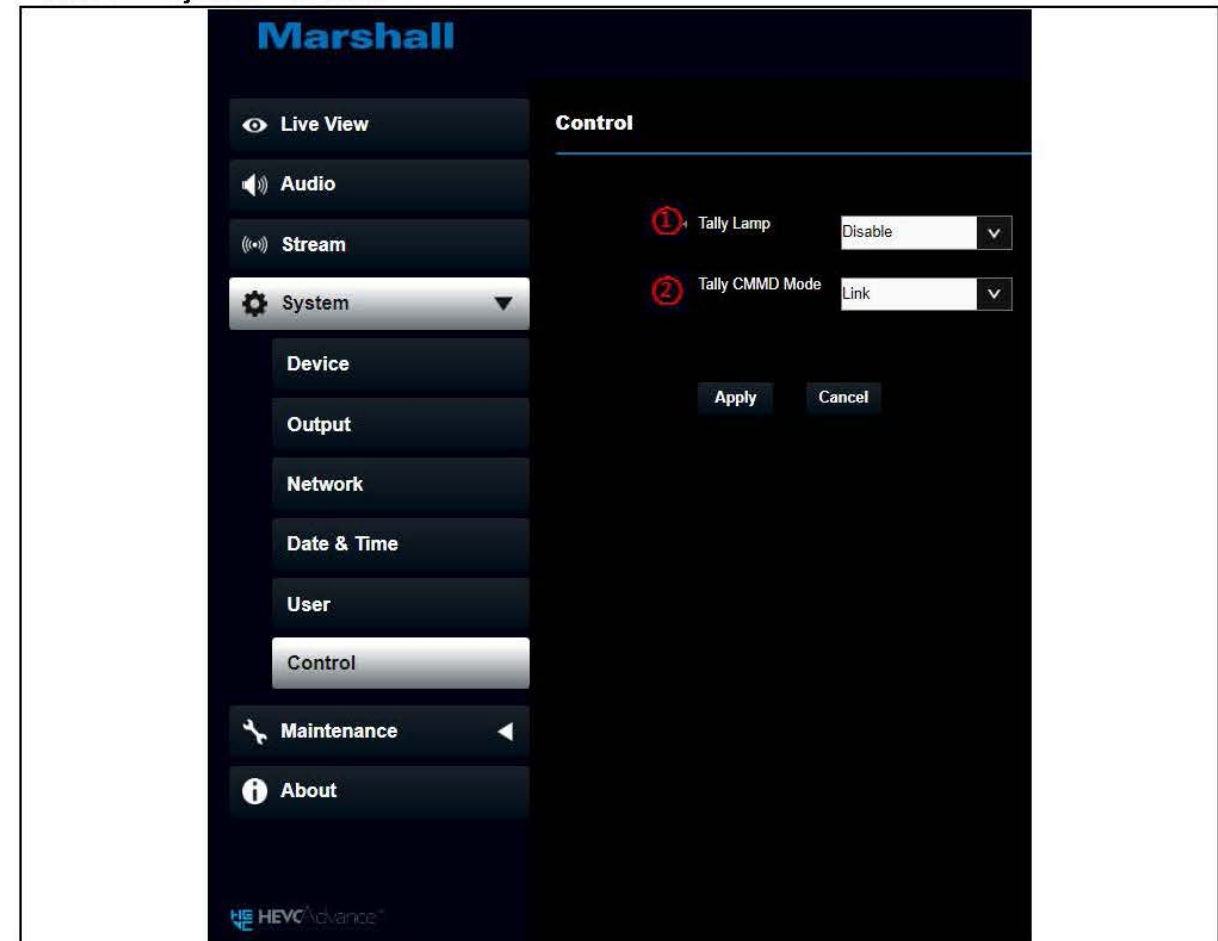

No	Item	Function Descriptions
1	Tally Lamp	Enable/ disable Tally Lamp function.
2	Tally CMMD Mode	Set if the Tally lamp is linked with RS232 command <ul style="list-style-type: none"> Normal (non-linked): The tally lamp and the mode need to be set separately. Tally lamp On: default mode is no light, need to send command to set the lamp mode Tally lamp Off: when set the mode, it will not be triggered to enable the tally lamp function.. Link: <ul style="list-style-type: none"> Tally lamp On: the default lamp mode is red light. Tally lamp Off: when set the mode, it will trigger to enable the tally lamp function.

6.3.12 Maintenance

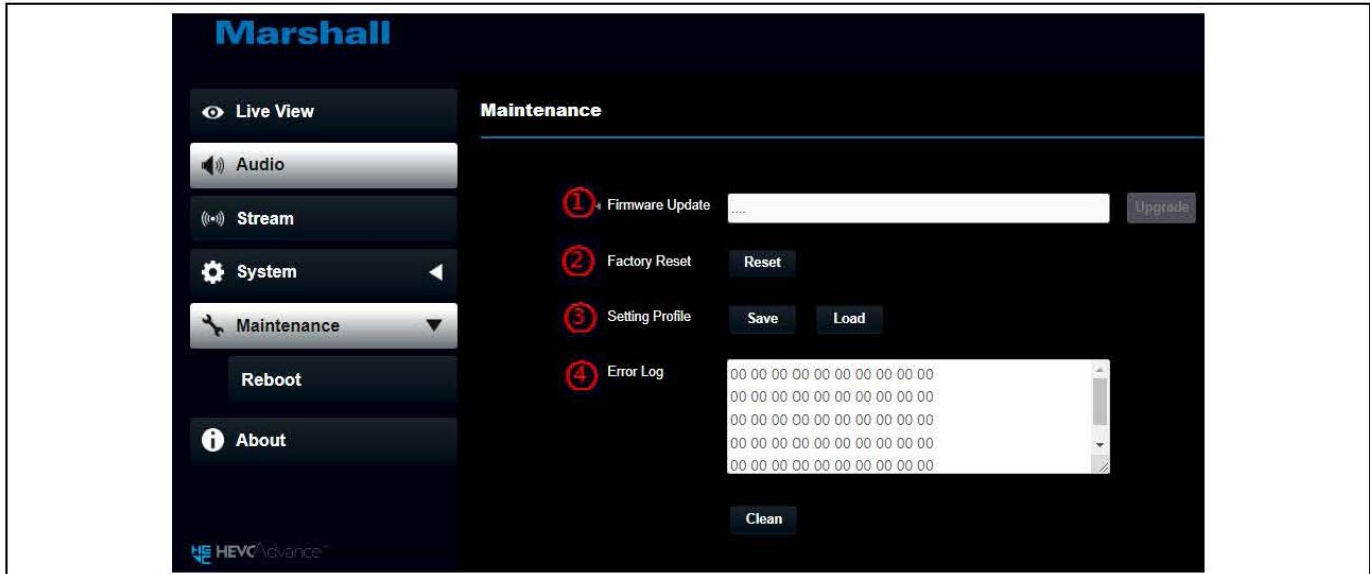

No	Item	Function Descriptions
1	Firmware Update	Select the firmware file, and click [Upgrade] to update the firmware. ※ Update takes about 1 - 2 minutes. ※ Please do not operate or turn off the power of the device during the update to avoid firmware update failure.
2	Factory Reset	Restore the factory default setting
3	Setting Profile	Save setup parameters as a Profile, and users can download and upload camera setup parameters
4	Error Log	If the camera encounters errors, an error code log will be established ※When an error code appears, please try to clear it to make sure whether the issue has occurred repetitively



No	Item	Function Descriptions
1	Reboot	Reboot immediately
2	Disable	Disable/ Enable the reboot settings
3	Daily reboot	Set the daily reboot time; Adjustable when the Enable is set to opened.

6.3.14 About



Function Descriptions

Display the firmware version, serial number, and other related information of the camera
For technical support, please scan the QRcode at the bottom right.

Chapter 1 Troubleshooting

This chapter describes common trouble shooting methods you may find useful while using CV420e. If you have questions, please refer to related chapters and follow all the suggested solutions. If the problem persists, please contact your distributor or Marshall service center.

No.	Problems	Solutions
1.	Boot without power signal	<ol style="list-style-type: none"> 1. Make sure you have plugged in the power cord. 2. When using a PoE connection, ensure that the power supply supports IEEE 802.3af hubs
2.	There is no image output from CV420e	<ol style="list-style-type: none"> 1. Check the power supply or PoE supply functions. 2. Confirm the output signals are in streaming output. 3. If the camera is connected to a monitor, confirm the monitor equipment supports 4K output. 4. Replace the cables and make sure they are not faulty.
3.	CV420e image is severely delayed	<ol style="list-style-type: none"> 1. Please use 4K, 1080p or 720p 60/50 Hz signals rather than 25/30 Hz signals.
4.	RS-232 over IP cannot be controlled	<ol style="list-style-type: none"> 1. Please make sure the port number (52381) is set correctly 2. For related command settings, please download the Command Set Manual from Marshall official website
5.	The ONVIF software cannot find the machine	Please make sure that [Setting]> [Video]> [Camera ID]/[Location] in the webpage uses only English letters or numbers. The ONVIF software cannot find the machine if you use special characters and space.

CHAPTER 8: SAFETY INSTRUCTIONS

Always follow these safety instructions when setting up and using the CV420e Compact UHD60 Camera:

1 Operation

- 1.1 Please use the product in the recommended operating environment, away from water or source of heat.
- 1.2 Do not place the product on a tilted or unstable trolley, stand or table.
- 1.3 Please clean the dust on the power plug prior to usage. Do not insert the product's power plug into a multiplug to prevent sparks or a fire.
- 1.4 Do not block the slots and openings in the case of the product. They provide ventilation and prevent the product from overheating.
- 1.5 Do not open or remove covers, otherwise it may expose you to dangerous voltages and other hazards. Refer all servicing to licensed service personnel.
- 1.6 Unplug the product from the wall outlet and refer servicing to licensed service personnel when the following situations happen:
 - If the power cords are damaged or frayed.
 - If liquid is spilled into the product or the product has been exposed to rain or water.

2 Installation

- 2.1 For security considerations, please make sure the standard hanging rack you bought is in line with UL or CE safety approbations and installed by technician personnel approved by agents.

3 Storage

- 3.1 Do not place the product where the cord can be stepped on as this may result in fraying or damage to the lead or the plug.
- 3.2 Unplug this product during thunderstorms or if it is not going to be used for an extended period.
- 3.3 Do not place this product or accessories on top of vibrating equipment or heated objects.

4 Cleaning

- 4.1 Disconnect all the cables prior to cleaning and wipe the surface with a dry cloth. Do not use alcohol or volatile solvents for cleaning.

5 Batteries (for products or accessories with batteries)

- 5.1 When replacing batteries, please only use similar or the same type of batteries.
- 5.2 When disposing of batteries or products, please adhere to the relevant instructions in your country or region for disposing of batteries or products.

■ Precautions



This symbol indicates that this equipment may contain dangerous voltage which could cause electric shock. Do not remove the cover (or back). No user-serviceable parts inside. Refer servicing to licensed service personnel.



This symbol indicates that there are important operating and maintenance instructions in this User Manual with this unit.

■ FCC Warning

This equipment has been tested and found to comply with the limits for a Class A digital device, pursuant to part 15 of the FCC Rules. These limits are designed to provide reasonable protection against harmful interference when the equipment is operated in a commercial environment.

Notice :

The changes or modifications not expressly approved by the party responsible for compliance could void the user's authority to operate the equipment.

This equipment has been tested and found to comply with the limits for a Class A digital device, pursuant to part 15 of the FCC Rules. These limits are designed to provide reasonable protection against harmful interference when the equipment is operated in a commercial environment.

■ IC Warning

This digital apparatus does not exceed the Class A limits for radio noise emissions from digital apparatus as set out in the interference-causing equipment standard entitled "Digital Apparatus," ICES-003 of Industry Canada.

Cet appareil numérique respecte les limites de bruits radioélectriques applicables aux appareils numériques de Classe A prescrites dans la norme sur le matériel brouilleur: "Appareils Numériques," NMB-003 édictée par l'Industrie.

■ EN55032 CE Warning

Operation of this equipment in a residential environment could cause radio interference.

Warning: Operation of this equipment in a residential environment may cause radio interference.

Marshall

Warranty

For Warranty information please refer to Marshall website page:

<https://marshall-usa.com/company/warranty.php>

Marshall

20608 Madrona Avenue, Torrance, CA 90503

Tel: (800) 800-6608 / (310) 333-0606 • Fax: 310-333-0688

www.marshall-usa.com

support@marshall-usa.com